

# ET51/56

## Enterprise Tablet



## User Guide for Android™ 8.1.0 Oreo



**ZEBRA**

# Copyright

ZEBRA and the stylized Zebra head are trademarks of Zebra Technologies Corporation, registered in many jurisdictions worldwide. Google, Android, Google Play and other marks are trademarks of Google LLC; Oreo is a trademark of Mondelez International, Inc. group. All other trademarks are the property of their respective owners. ©2021 Zebra Technologies Corporation and/or its affiliates. All rights reserved.

COPYRIGHTS & TRADEMARKS: For complete copyright and trademark information, go to [zebra.com/copyright](http://zebra.com/copyright).

WARRANTY: For complete warranty information, go to [zebra.com/warranty](http://zebra.com/warranty).

END USER LICENSE AGREEMENT: For complete EULA information, go to [zebra.com/eula](http://zebra.com/eula).

# Terms of Use

- Proprietary Statement

This manual contains proprietary information of Zebra Technologies Corporation and its subsidiaries (“Zebra Technologies”). It is intended solely for the information and use of parties operating and maintaining the equipment described herein. Such proprietary information may not be used, reproduced, or disclosed to any other parties for any other purpose without the express, written permission of Zebra Technologies.

- Product Improvements

Continuous improvement of products is a policy of Zebra Technologies. All specifications and designs are subject to change without notice.

- Liability Disclaimer

Zebra Technologies takes steps to ensure that its published Engineering specifications and manuals are correct; however, errors do occur. Zebra Technologies reserves the right to correct any such errors and disclaims liability resulting therefrom.

- Limitation of Liability

In no event shall Zebra Technologies or anyone else involved in the creation, production, or delivery of the accompanying product (including hardware and software) be liable for any damages whatsoever (including, without limitation, consequential damages including loss of business profits, business interruption, or loss of business information) arising out of the use of, the results of use of, or inability to use such product, even if Zebra Technologies has been advised of the possibility of such damages. Some jurisdictions do not allow the exclusion or limitation of incidental or consequential damages, so the above limitation or exclusion may not apply to you.

# Revision History

Changes to the original guide are listed below:

Change	Date	Description
-01 Rev A	7/2019	Initial release
-02 Rev. A	10/2019	Update accessory list, cradle drawings, and charging with Power Pack instructions.
-03 Rev. A	12/2019	Add support for ET51 Enterprise Tablet with Integrated Scanner.
-04EN Rev. A	5/2020	Add support for USB-C charging.

Change	Date	Description
-05EN Rev. A	3/2021	Change charging LED from orange to blinking amber. Remove USB-C charging info.
-06EN Rev. A	10/4/21	Add new tall insert to Charge only Cradle.
-07EN Rev. A	12/2021	Remove Power Pack beep alert note on page 140 and page 148.

# Table of Contents

Copyright .....	2
Terms of Use .....	2
Revision History .....	2
<b>About This Guide .....</b>	<b>11</b>
Introduction .....	11
Configurations .....	11
Software Versions .....	12
Chapter Descriptions .....	12
Notational Conventions .....	12
Related Documents and Software .....	13
Service Information .....	13
<b>Getting Started .....</b>	<b>14</b>
Introduction .....	14
Unpacking .....	14
ET51/56 Features .....	15
ET51 with Integrated Scanner Features .....	18
Getting Started .....	19
Installing a microSD Card .....	20
Install the microSD Card .....	21
Install the nano SIM Card .....	21
Charging the Battery .....	24
Zebra Visibility Services .....	24
Google Account Setup .....	24
Turning Off the Tablet .....	24
Replacing the SIM Card .....	25
Replacing the microSD Card .....	25
Interactive Sensor Technology .....	26
Turning Off the Display .....	26

## Table of Contents

Battery Management .....	26
Monitoring Battery Usage .....	26
Low Battery Notification .....	27
Battery Optimization .....	27
Turning Off the Radios .....	28
Setting the Date and Time .....	28
Display Settings .....	29
Setting the Screen Brightness .....	29
Setting Screen Timeout .....	29
Setting Font Size .....	29
Setting Screen Rotation .....	30
Touch Panel Mode .....	31
General Sound Setting .....	31
Limit Sounds and Vibrations .....	33
Total Silence .....	33
Alarms Only .....	33
Priority Notifications Only .....	34
Automatically Block Sounds and Vibrations .....	34
Silence Sounds During Certain Times .....	34
Silence Sounds During Events and Meetings .....	35
Turn Sounds Back On .....	35
Override Do Not Disturb for Specific Apps .....	35
<b>Using the Tablet .....</b>	<b>37</b>
Introduction .....	37
Google Mobile Services .....	37
Home Screen .....	37
Home Screen .....	38
Status Bar .....	38
Status Icons .....	39
Notification Icons .....	40
Managing Notifications .....	41
Quick Access Panel .....	41
App Shortcuts and Widgets .....	43
Adding an App Shortcut to the Home Screen .....	43
Adding a Widget to the Home Screen .....	43
Moving Items on the Home Screen .....	43
Removing an App Shortcut or Widget from the Home Screen .....	43
Folders .....	44
Holding the Device .....	44
Using the Touchscreen .....	44
Keyboard Configuration .....	45

## Table of Contents

Enabling Keyboards .....	45
Switching Between Keyboards .....	45
Editing Text .....	45
Entering Numbers, Symbols, and Special Characters .....	45
Apps .....	46
Accessing Apps .....	48
Switching Between Recent Apps .....	49
Un-Locking the Screen .....	50
Suspend Mode .....	53
Resetting the Device .....	53
Performing a Soft Reset .....	53
Performing a Hard Reset .....	53
<b>Applications .....</b>	<b>54</b>
Introduction .....	54
Battery Manager .....	54
Camera .....	57
Taking Photos .....	57
Recording Videos .....	58
Photo Settings .....	58
Front Camera .....	58
Rear Camera .....	59
Video Settings .....	60
Front Camera .....	60
Rear Camera .....	61
Contacts .....	62
Adding a Contact .....	62
Editing Contacts .....	62
Deleting Contacts .....	62
DataWedge Demonstration .....	63
Scanner Selection .....	64
Device Central .....	66
Scan and Pair Tab .....	66
Scan and Pair .....	66
Scan to Pair .....	67
Manually Pairing .....	67
Peripherals Tab .....	67
My Device Tab .....	67
Unpairing a Peripheral .....	67
Paging an RS6000 Ring Scanner .....	68
Diagnostic Tool .....	68
Settings .....	71

## Table of Contents

Battery Test Information .....	71
System Test Information .....	72
WLAN Test Information .....	72
Bluetooth Test Information .....	72
Files .....	73
Photos .....	75
Working with Albums .....	76
Sharing an Album .....	76
Deleting an Album .....	77
Working with Photos .....	77
Viewing and Browsing Photos .....	77
Cropping a Photo .....	78
Setting a Photo as a Contact Icon .....	78
Sharing a Photo .....	79
Deleting a Photo .....	79
Working with Videos .....	79
Watching a Video .....	79
Sharing a Video .....	79
Deleting a Video .....	79
RxLogger .....	80
RxLogger Configuration .....	80
Configuration File .....	81
Enabling Logging .....	81
Disabling Logging .....	81
Extracting Log Files .....	81
RxLogger Utility .....	82
<b>Wireless .....</b>	<b>83</b>
Wireless Local Area Networks .....	83
Connecting to a Wi-Fi Network .....	84
Configuring a Secure Wi-Fi Network .....	85
Manually Adding a Wi-Fi Network .....	86
Configuring for a Proxy Server .....	87
Configuring the Device to Use a Static IP Address .....	88
Advanced Wi-Fi Settings .....	89
Additional Wi-Fi Settings .....	90
Wi-Fi Advanced Features .....	92
Resolving Wi-Fi and Bluetooth Wireless Interference Issues .....	92
Wireless Wide Area Networks .....	94
Sharing the Mobile Data Connection .....	94
Enabling USB Tethering .....	94
Enabling Bluetooth Tethering .....	94

## Table of Contents

Enabling Wi-Fi Hotspot .....	95
Configuring the Wi-Fi Hotspot .....	95
Data Usage .....	96
Setting Data Usage Warning .....	97
Disabling Data When Roaming .....	97
Locking the SIM Card .....	97
Configuring the Access Point Name .....	98
Bluetooth .....	99
Adaptive Frequency Hopping .....	99
Security .....	99
Bluetooth Profiles .....	100
Bluetooth Power States .....	101
Bluetooth Radio Power .....	101
Enabling Bluetooth .....	101
Disabling Bluetooth .....	102
Discovering Bluetooth Device(s) .....	102
Changing the Bluetooth Name .....	102
Connecting to a Bluetooth Device .....	102
Selecting Profiles on the Bluetooth Device .....	103
Unpairing a Bluetooth Device .....	103
Near Field Communications .....	103
Reading NFC Cards .....	104
<b>Data Capture.....</b>	<b>105</b>
Imaging .....	105
Scanning Considerations .....	105
Expansion Back .....	106
Integrated Scanner .....	106
RS507/RS507X Hands-Free Imager .....	106
RS6000 Bluetooth Ring Scanner .....	106
DS3678 Digital Scanner .....	107
DS2278 Digital Scanner .....	107
Scanning with SE4750 Expansion Back .....	107
Scanning with the Integrated Scanner .....	108
Scanning with RS507/RS507X Hands-Free Imager .....	110
Scanning with RS6000 Bluetooth Ring Scanner .....	111
Scanning with the DS3608 USB Scanner or DS3678 Bluetooth Scanner .....	112
Scanning with DS2278 Digital Scanner .....	113
Pairing the RS507/RS507X/RS6000 Hands-Free Imager .....	114
Pairing Using Simple Serial Interface (SSI) .....	114
Pairing Using Bluetooth Human Interface Device .....	115
Pairing a Bluetooth Scanner .....	116



## Table of Contents

Pairing Using Simple Serial Interface .....	116
Pairing Using Bluetooth Human Interface Device .....	117
Connecting a USB Scanner .....	117
Connecting Using Simple Serial Interface .....	117
Connecting Using HID Mode .....	117
DataWedge .....	119
Enabling DataWedge .....	119
Disabling DataWedge .....	119
<b>Accessories .....</b>	<b>120</b>
Introduction .....	120
Charge Only Cradle .....	123
Installing the Short Insert .....	123
Installing the Tall Insert .....	124
Charging the Device .....	125
Communication and Charging Cradle .....	127
Installing the Insert .....	128
Charging the Device .....	129
Rugged Communication and Charging Cradle .....	131
Charging the Device .....	132
4-Slot Charge Only Cradle .....	135
Insert Installation .....	136
Insert Tablet into Slot .....	136
Device without Rugged Frame .....	136
Device with Rugged Frame .....	137
Charging the Battery .....	137
Rugged Charge Connector .....	138
Power Pack .....	140
Charging the Power Pack .....	141
Using Cradle .....	141
Using the 4-Slot Battery Charger .....	142
Charging the Power Pack .....	142
<b>Maintenance and Troubleshooting .....</b>	<b>144</b>
Introduction .....	144
Maintaining the Device .....	144
Battery Safety Guidelines .....	144
Cleaning Instructions .....	145
Approved Cleanser Active Ingredients .....	145
Harmful Ingredients .....	145
Device Cleaning Instructions .....	146

## Table of Contents

Special Cleaning Notes .....	146
Cleaning Materials Required .....	146
Cleaning Frequency .....	146
Cleaning Battery Connectors .....	146
Cleaning Cradle Connectors .....	147
Troubleshooting .....	148
<b>Specifications.....</b>	<b>149</b>
Technical Specifications .....	149

### Index

# About This Guide

## Introduction

This guide provides information about using the device and accessories.



**NOTE:** Screens and windows pictured in this guide are samples and can differ from actual screens.

## Configurations

This guide covers the following configurations:

*Table 1 Configurations*

Configuration	Operating System	Radios	Display	Memory	Data Capture
ET51CE	8.1.0 Oreo	WLAN: 802.11a/b/g/n/ac/d/h/i/k/r WPAN: Bluetooth	8.4" color	4 GB RAM/ 32 GB Flash	Camera, SE4750 Expansion Back, RS507, RS507X, RS6000, DS3608, DS3678, DS3578, DS2278.
ET51CE with Integrated Scanner	8.1.0 Oreo	WLAN: 802.11a/b/g/n/ac/d/h/i/k/r WPAN: Bluetooth	8.4" color	4 GB RAM/ 32 GB Flash	Camera, integrated scanner, RS507, RS507X, RS6000, DS3608, DS3678, DS3578, DS2278.
ET51CT	8.1.0 Oreo	WLAN: 802.11a/b/g/n/ac/d/h/i/k/r WPAN: Bluetooth	10.1" color	4 GB RAM/ 32 GB Flash	Camera, SE4750 Expansion Back, RS507, RS507X, RS6000, DS3608, DS3678, DS3578, DS2278.
ET56DE	8.1.0 Oreo	WLAN: 802.11a/b/g/n/ac/d/h/i/k/r WPAN: Bluetooth WWAN: LTE	8.4" color	4 GB RAM/ 32 GB Flash	Camera, SE4750 Expansion Back, RS507, RS507X, RS6000, DS3608, DS3678, DS3578, DS2278.

## Software Versions

To determine the current software versions:

1. Swipe down from the Status bar to open the Quick Settings bar.
2. Touch **⚙️ > System**.
3. Touch **About phone**.
4. Scroll to view the following information:
  - **Model**
  - **Android version**
  - **Android security patch version**
  - **Baseband version**
  - **Kernel version**
  - **Build number**.

To determine the device serial number, touch **About tablet > Status**.

- **Serial number**

## Chapter Descriptions

Topics covered in this guide are as follows:

- [Getting Started](#), provides information on getting the tablet up and running for the first time.
- [Using the Tablet](#), explains how to use the tablet. This includes instructions for powering on and resetting the tablet, entering and capturing data.
- [Applications](#), provides information on using applications installed on the tablet.
- [Wireless](#), explains how to configure and use the wireless functionality on the tablet.
- [Data Capture](#), explains how to capture data using the optional scanners.
- [Accessories](#), describes the accessories available for the tablet and how to use the accessories with the tablet.
- [Maintenance and Troubleshooting](#), includes instructions on cleaning and storing the tablet, and provides troubleshooting solutions for potential problems during tablet operation.
- [Specifications](#), includes a table listing the technical specifications for the tablet.

## Notational Conventions

The following conventions are used in this document:

- Tablet refers to the Zebra ET51 or ET56 tablet.

- **Bold** text is used to highlight the following:
  - Dialog box, window and screen names
  - Drop-down list and list box names
  - Check box and radio button names
  - Icons on a screen
  - Key names on a keypad
  - Button names on a screen.
- Bullets (•) indicate:
  - Action items
  - Lists of alternatives
  - Lists of required steps that are not necessarily sequential.
- Sequential lists (for example, those that describe step-by-step procedures) appear as numbered lists.

## Related Documents and Software

The following documents provide more information about the tablet.

- ET51/56 Enterprise Tablet Quick Reference Guide, p/n MN-003332-xx
- ET51 Enterprise Tablet with Integrated Scanner Quick Reference Guide, p/n MN-003777-xx.
- ET51/56 Integrator Guide for Android 8.1.0 Oreo, p/n MN-003458-xx

For the latest version of this guide and all guides, go to: [zebra.com/support](http://zebra.com/support).

## Service Information

If you have a problem with your equipment, contact Customer Support for your region. Contact information is available at: [zebra.com/support](http://zebra.com/support).

When contacting support, please have the following information available:

- Serial number of the unit (found on manufacturing label)
- Model number or product name (found on manufacturing label)
- Software type and version number
- IMEI number.

Customer Support responds to calls by email or telephone within the time limits set forth in support agreements.

If the problem cannot be solved by Customer Support, you may need to return the equipment for servicing and will be given specific directions. We are not responsible for any damages incurred during shipment if the approved shipping container is not used. Shipping the units improperly can possibly void the warranty. Remove the SIM card and/or microSD card from the device before shipping for service.

If the device was purchased from a business partner, contact that business partner for support.

# Getting Started

## Introduction

This chapter explains how to set the device up for the first time.

## Unpacking

Carefully remove all protective material from around the tablet and save the shipping container for later storage and shipping.

Verify that you received all equipment listed below:

- Tablet with lithium-ion battery
- Quick Reference Guide
- Additional hand strap screws (ET51 Enterprise Tablet with integrated Scanner only).
- Cradle caps (ET51 Enterprise Tablet with integrated Scanner only).

Inspect the equipment for damage. If you are missing any equipment or if you find any damaged equipment, contact the Zebra Support Center immediately. See [Service Information](#) for contact information.

## ET51/56 Features

Figure 1 ET51/ET56 Front View

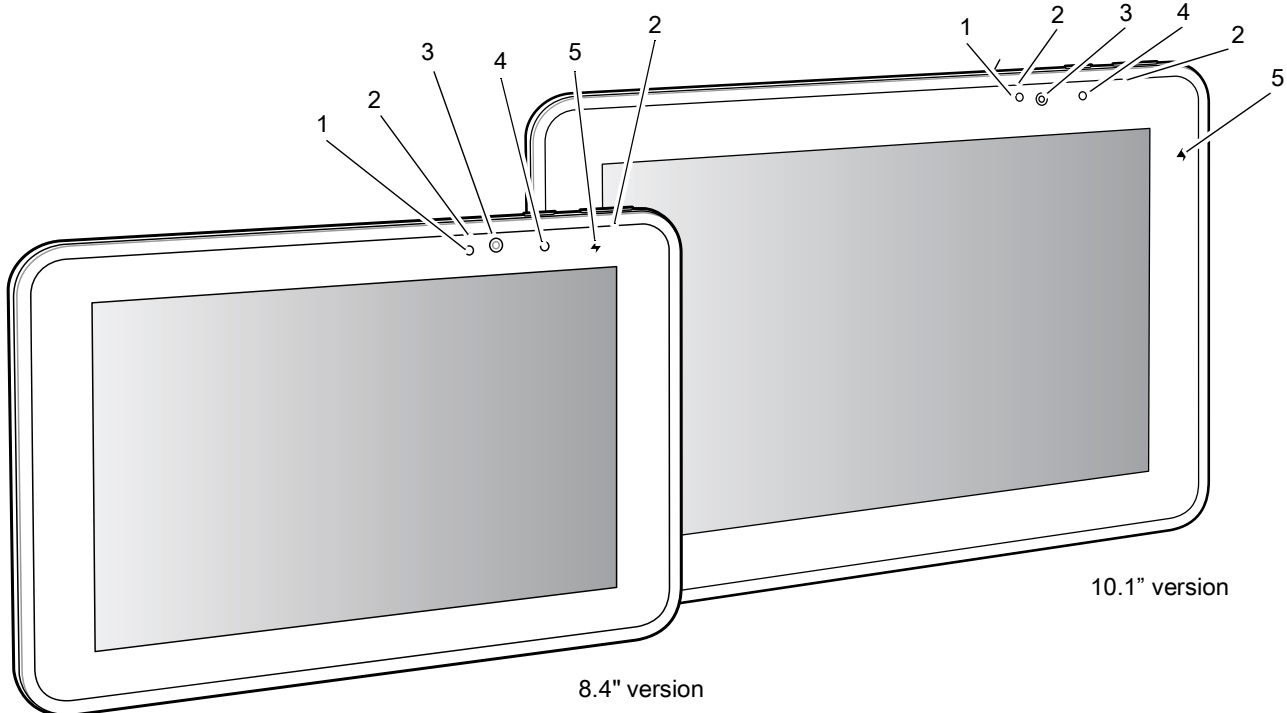


Table 2 ET51/ET56 Front View

Item	Description
1	Ambient Light Sensor - Recognizes the ambient light and adjusts the display brightness (if enabled).
2	Dual Front-Facing Microphones - Use for voice communications for audio recordings.
3	Front Facing Camera - Use for video conferencing or capturing images and video.
4	Notification LED - Lights blue when an application sends a notification.
5	Charging Indicator LED - Indicates charging status. <ul style="list-style-type: none"> <li>• Off - device is not connected to charger.</li> <li>• Blinking amber - device is charging.</li> <li>• Green - device is connected and fully charged.</li> <li>• Red - charge error.</li> </ul>

Figure 2 ET51/ET56 Back View

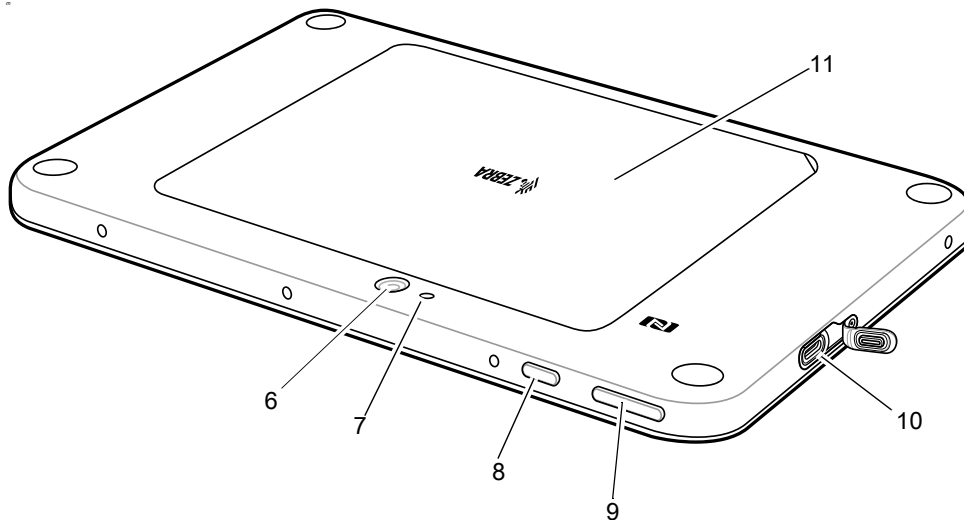


Table 3 ET51/ET56 Back View

Item	Description
6	Rear Camera - Auto-focus camera for capturing high resolution images and video.
7	Camera LED Flash - Provides illumination for the camera.
8	Power Button - Push once to start the device; push it again to enable sleep mode. Push and hold it to shut down the tablet.
9	Volume Key - Push the left side to reduce the volume. Press the right side to increase the volume.
10	USB-C / Display - Provides communications with a host computer using a USB-C cable or a video monitor using a third-party adapter.
11	Battery Cover - Covers the replaceable battery.



Figure 3 ET51/ET56 Bottom View

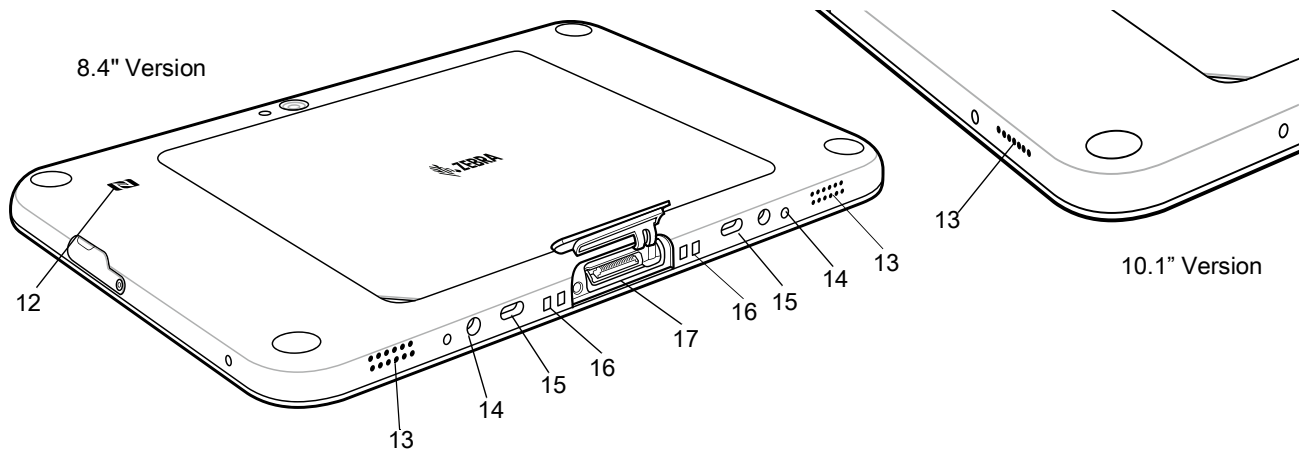


Table 4 Bottom View

Item	Description
12	NFC Antenna Position - Use to read NFC cards.
13	Stereo Speakers - Provides audio playback.
14	Alignment Holes - Use to align tablet with cradle
15	Latching Slots - Insertion point for Communication and Charging cradle locks.
16	Charging Pins - Contact point for cradle charging.
17	Docking Connector - Interfaces with the cradle.

## ET51 with Integrated Scanner Features

Figure 4 ET51 with Integrated Scanner Front View

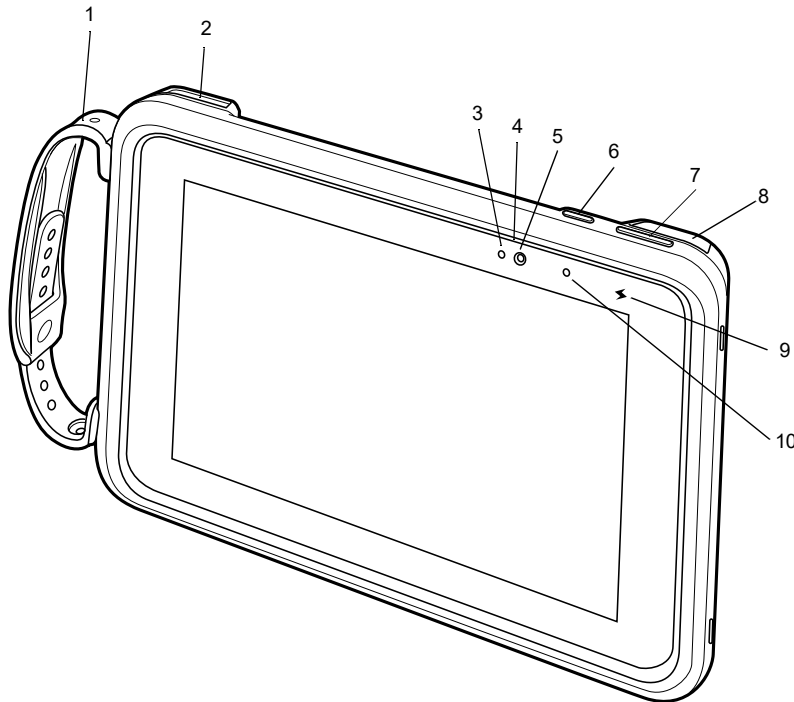


Table 5 ET51 with Integrated Scanner Front View

Item	Description
1	Adjustable Hand Strap - Use to securely hold the device in your hand.
2	Exit Window - Provides data capture using the imager.
3	Ambient Light Sensor - Recognizes the ambient light and adjusts the display brightness (if enabled).
4	Dual Front-Facing Microphones - Use for voice communications for audio recordings.
5	Front Facing Camera - Use for video conferencing or capturing images and video.
6	Power Button - Push once to start the device; push it again to enable sleep mode. Push and hold it to shut down the device.
7	Volume Key - Press the left side to reduce the volume. Press the right side to increase the volume.
8	USB-C Port - Use to charge the device using a USB-C cable and power supply.
9	Charging Indicator LED - Indicates charging status. <ul style="list-style-type: none"> <li>• Off - device is not connected to charger.</li> <li>• Blinking amber - device is charging.</li> <li>• Green - device is connected and fully charged.</li> <li>• Red - charge error.</li> </ul>
9	Notification LED - Lights blue when an application sends a notification.

Figure 5 ET51 with Integrated Scanner Back View

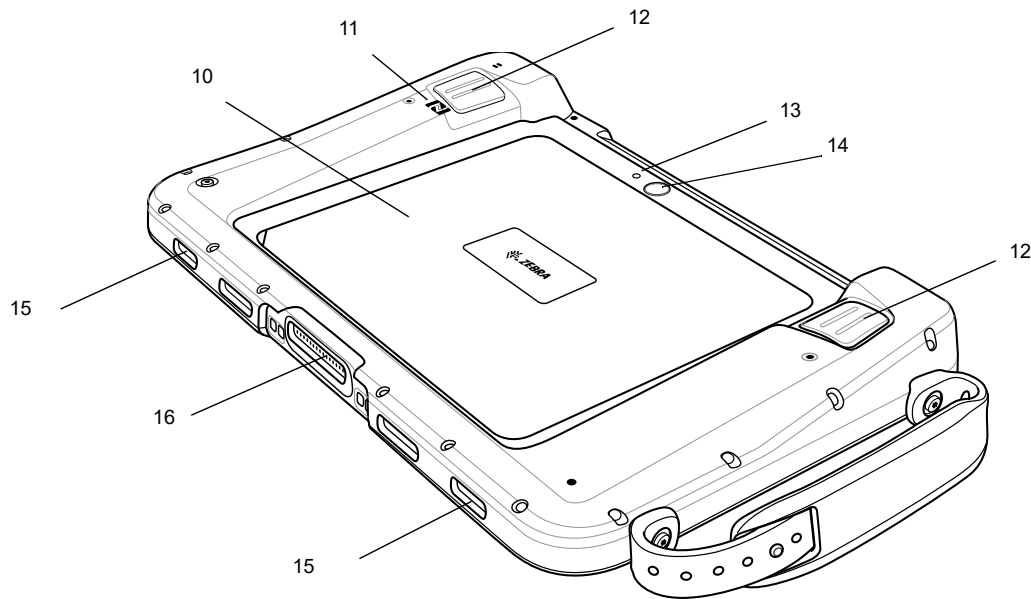


Table 6 ET51 with Integrator Scanner Back View

Item	Description
10	Back Cover - Covers the replaceable battery.
11	NFC Antenna Position - Use to read NFC cards.
12	Scan Button - Initiates barcode data capture when a scan-enabled application is active.
13	Rear Camera - Use for high resolution images and video.
14	Camera LED Flash - Provides illumination for the camera.
15	Stereo Speakers - Provides audio playback.
16	Docking Connector - Interfaces with the cradle.

## Getting Started

In order to start using the device for the first time:

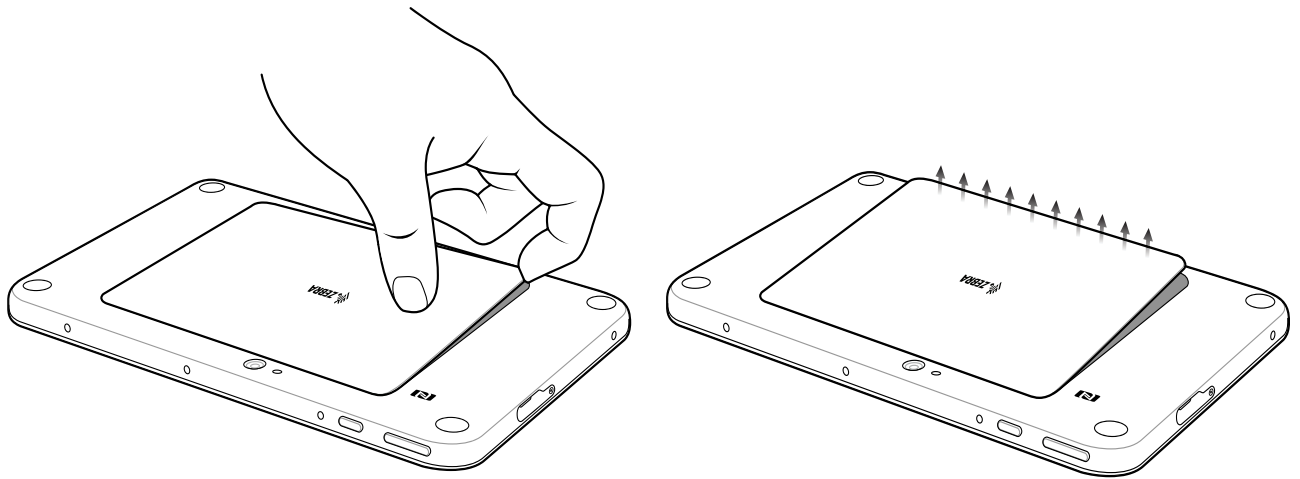
- Install microSD card
- Install nano SIM Card (ET56 only)
- Charge the device
- Perform basic configuration.

## Installing a microSD Card

To install a microSD card:

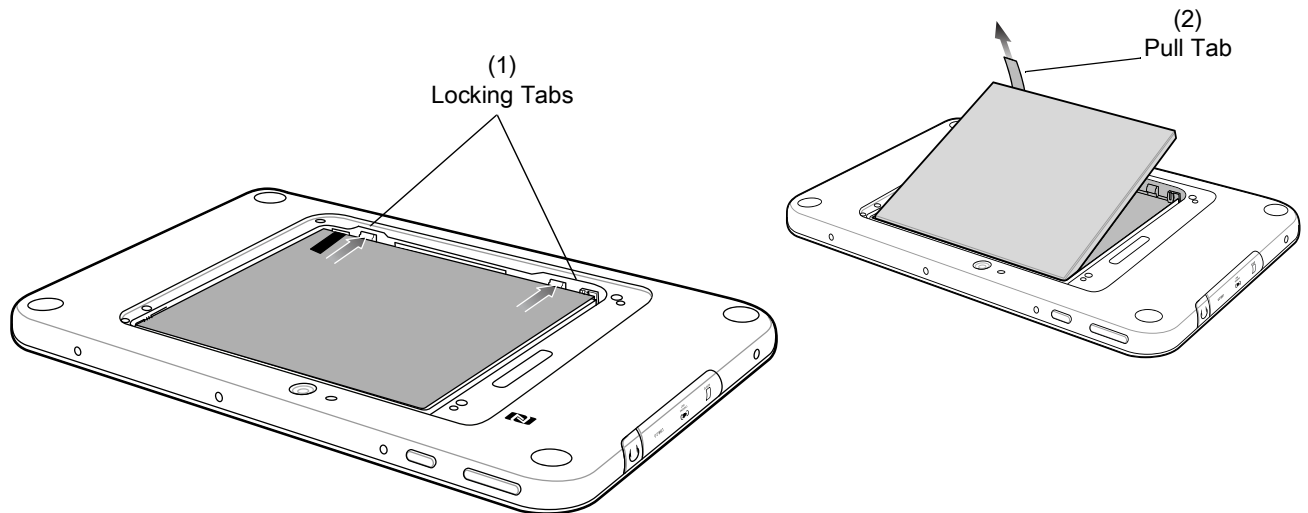
1. Press and hold the Power button until the menu appears.
2. Touch **Power off**.
3. Lift the notched corner of the battery cover and carefully lift the battery cover off the device.

**Figure 6** Lifting Battery Cover

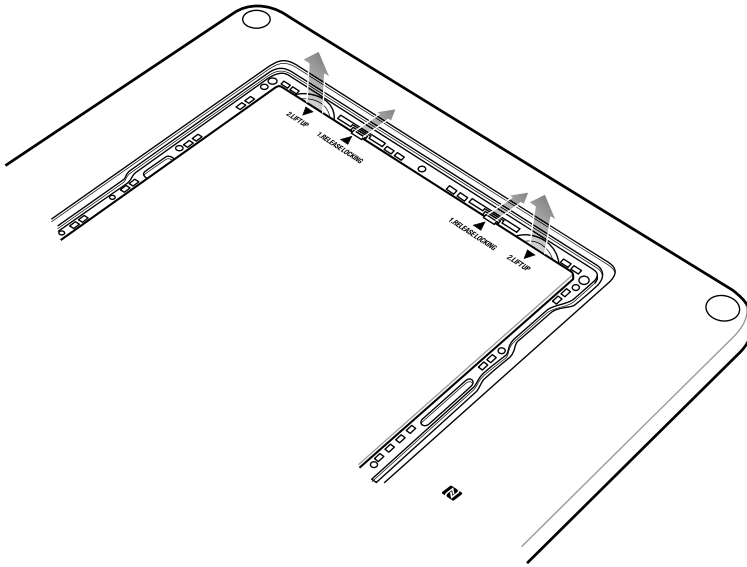


4. On the 8.4" version, push the two locking tabs up, then pull up on the tab to remove battery.  
On the 10.1" version, push the two locking tabs up (1), then lift the battery up (2).

**Figure 7** Removing the Battery - 8.4"



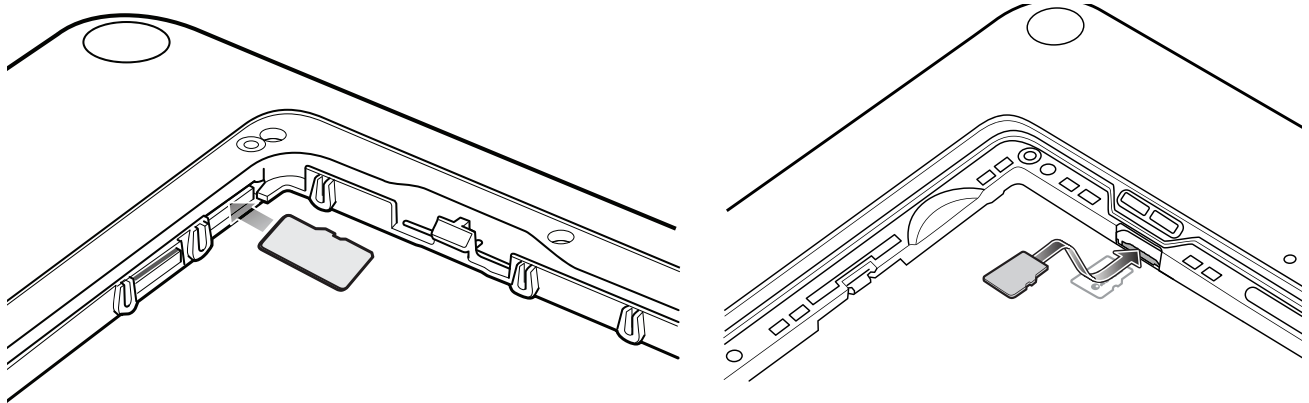
**Figure 8** Removing the Battery - 10.1"



### Install the microSD Card

1. Insert the microSD card with contacts facing down; 8.4" version shown here.

**Figure 9** Inserting microSD Card



8.4" Version

10.1" Version

2. Push the micro SD card in and ensure that it locks into place.

### Install the nano SIM Card

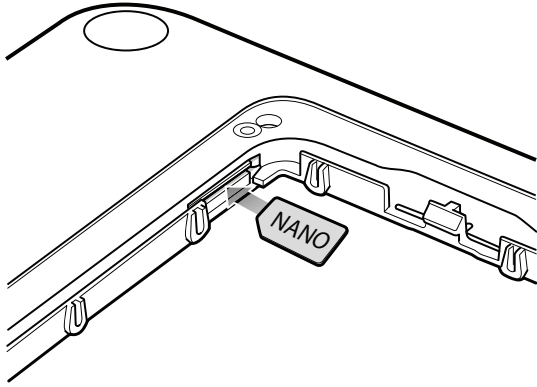


**NOTE:** ET56 only.

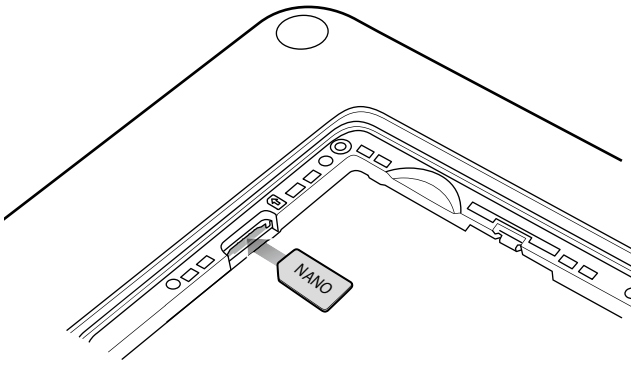
To install the nano SIM card:

1. Insert the nano SIM card with contacts facing down.

**Figure 10** Inserting the nano SIM Card - 8.4”

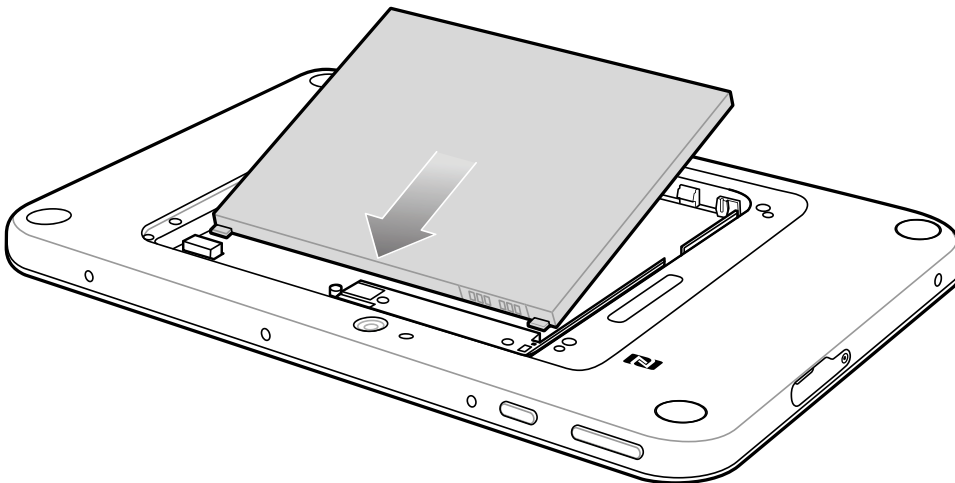


**Figure 11** Inserting the nano SIM Card - 10.1”



2. Push the SIM card in and ensure that it locks into place.
3. Replace the battery.
4. Press the battery down to ensure the two battery latches engage.

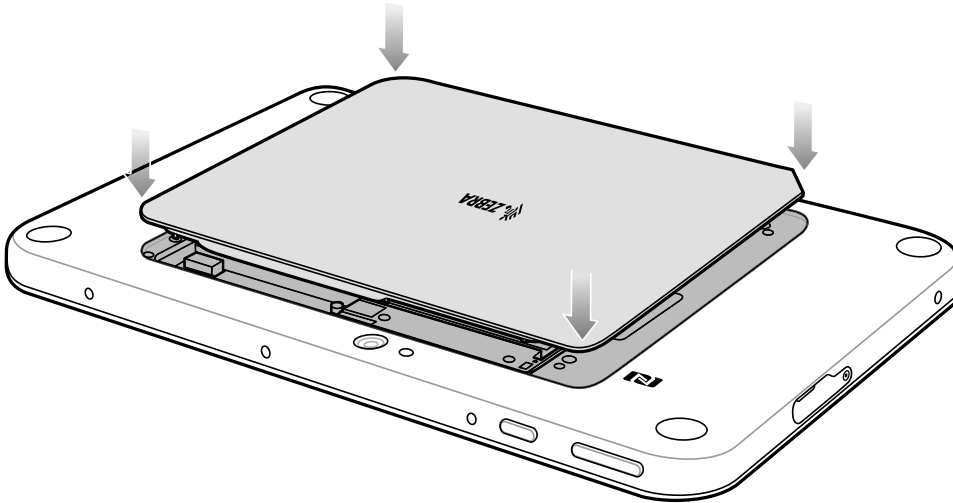
**Figure 12** Inserting the Battery



**CAUTION:** Be aware of the orientation of the battery cover. Failure to replace the battery cover properly may damage the battery cover.

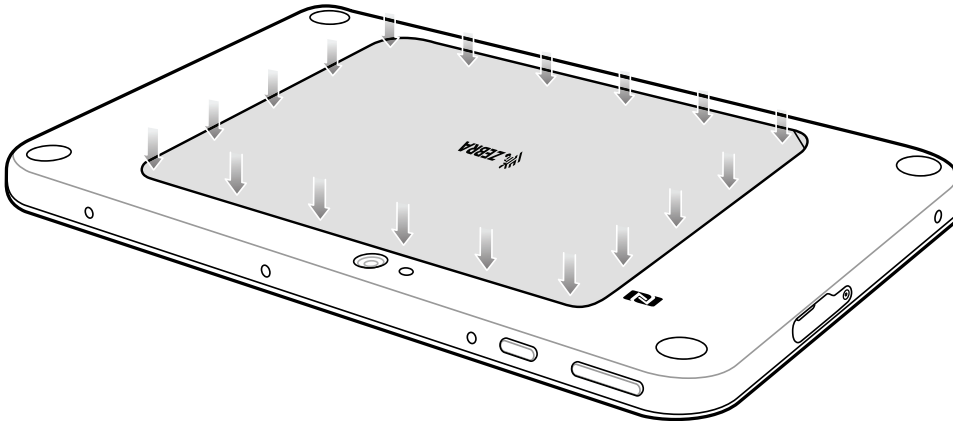
5. Align the tabs on the underside of the cover with the slot around the battery well. Make sure that the notch on the battery cover is at the bottom left corner of the device.

**Figure 13** Aligning the Battery Cover



6. Carefully press down around the edge of the cover. Make sure that the cover is seated properly.

**Figure 14** Pressing Down on the Battery Cover



7. Press Power button to turn on the device.

## Charging the Battery

Use one of the cradles to charge the main battery installed in the device. See the chapter [Accessories](#) for charging accessories. See the ET51/56 Integrator Guide for information about battery management.

The 8.4" tablet main battery charges from fully depleted to 90% in approximately 2.5 hours and from fully depleted to 100% in approximately 3.5 hours.

The 10.1" tablet main battery charges from fully depleted to 90% in approximately three hours and from fully depleted to 100% in approximately four hours.

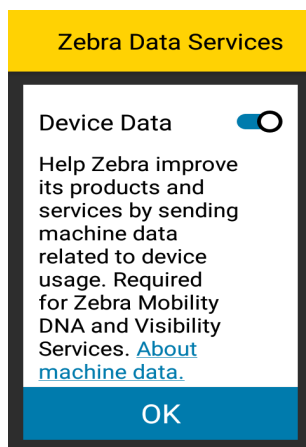


**NOTE:** The Charging indicator only illuminates when the tablet is connected to AC power.

## Zebra Visibility Services

The device captures and provides device analytics to a system administrator. The first time the device boots (or after a factory reset), the **Zebra Services** agreement screen displays.

Figure 15 Zebra Services



Touch the **Device Data** switch to disable the device from sending analytics data, then touch **OK**. Zebra recommends keeping this option enabled.

## Google Account Setup



**NOTE:** The device has to be connected to the internet in order to set up a Google™ account. A Google account is only required on devices with GMS software.

The first time the device starts, the Setup Wizard displays. Follow the on-screen instructions to set up a Google account, configure Google Pay™ for purchasing items from the Google Play™ store, to enter your personal information, and enable backup/restore features.

## Turning Off the Tablet



**NOTE:** After the device is powered off and external power is applied to the device, the device will automatically power on. This includes powered cradles, Expansion Back with Power Pack, Rugged Charge Connector, and power supply/USB-C cable.



To turn off the device:

1. Press and hold the power button until the menu appears.
2. Touch **Power off**.

## Replacing the SIM Card



**NOTE:** ET56DE only.



**CAUTION:** To avoid damage to the SIM slot, do not pull the SIM card out of the SIM slot. Push the SIM card in to eject it.

To replace the SIM card:

1. Press and hold the Power button until the menu appears.
2. Touch **Power off**.
3. Lift the notched corner of the battery cover and carefully lift the battery cover off the device.
4. On the 8.4" version, push the two locking tabs up, then pull up on the tab to remove battery.  
On the 10.1" version, push the two locking tabs up, then lift the battery up.
5. Push in the SIM card and release. The card eject slightly.
6. Remove the SIM card from the card slot. The card should easily slide out. If not, the SIM card was not ejected correctly. Repeat step 5.
7. Replace the battery.
8. Press the battery down to ensure the two battery latches engage.
9. Replace the battery cover.

## Replacing the microSD Card



**CAUTION:** To avoid damage to the microSD card slot, do not pull the microSD card out of the microSD Card slot. Push the microSD card in to eject it.

To replace the microSD card:

1. Press and hold the Power button until the menu appears.
2. Touch **Power off**.
3. Lift the notched corner of the battery cover and carefully lift the battery cover off the device.
4. On the 8.4" version, push the two locking tabs up, then pull up on the tab to remove battery.  
On the 10.1" version, push the two locking tabs up, then lift the battery up.
5. Push in the SIM card and release. The card eject slightly.
6. Remove the microSD card from the card slot. The card should easily slide out. If not, the microSD card was not ejected correctly. Repeat step 5.
7. Insert the replacement microSD card with contacts facing down.
8. Push the microSD card in and ensure that it locks into place.

9. Replace the battery.
10. Press the battery down to ensure the two battery latches engage.
11. Replace the battery cover.

## Interactive Sensor Technology

The device contains sensors that monitor movement, orientation and ambient light:

- Gyroscope - Measures angular rotational velocity to detect rotation of the device.
- Accelerometer - Measures the linear acceleration of movement to detect the orientation of the device.
- Digital Compass - The digital compass or magnetometer provides simple orientation in relation to the Earth's magnetic field. As a result, the device always knows which way is North so it can auto rotate digital maps depending on the physical orientation of the device.
- Light Sensor - Detects ambient light and adjusts the screen brightness.

In order to take advantage of these sensors, applications use API commands. Refer to the Zebra Android EMDK for more information.

## Turning Off the Display


To turn off the display press and release the power button.

## Battery Management



**NOTE:** Prior to checking the battery charge level, remove the device from any AC power source (cradle or cable).

To check the charge status of the main battery, open **Settings** and touch **System > About phone > Battery Information**.

Alternately, swipe up from the bottom of the screen and touch  to open the **Battery Manager** app. Touch **Advanced info**. See [Battery Manager on page 54](#).

**Battery present status** indicates if the battery is present and **Battery level** lists the battery charge (as a percentage of fully charged). The battery percentage can also be viewed next to the battery icon in the quick access panel. Swipe down with two fingers from the status bar to open the quick access panel.

## Monitoring Battery Usage

The **Battery** screen provides battery charge details, power management options, and a list of apps that consume the most battery power.

Use the power management options to extend battery life, or touch an app to display details about its power consumption. Different apps display different information. Some apps include buttons that open screens with settings to adjust power use. Use the **DISABLE** or **FORCE CLOSE** buttons to turn off apps that consume too much power.


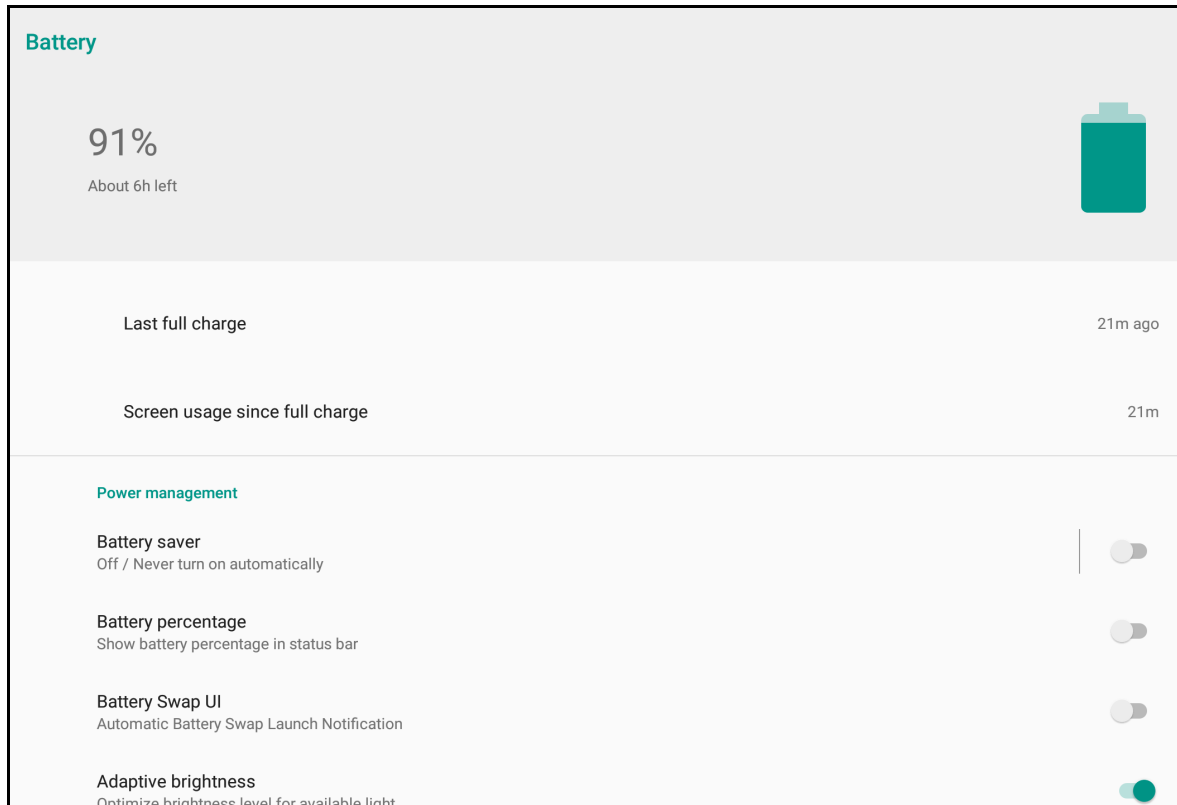
1. Swipe down from the Status bar to open the Quick Settings bar and then touch .
2. Touch **Battery**.

Figure 16 Battery Screen



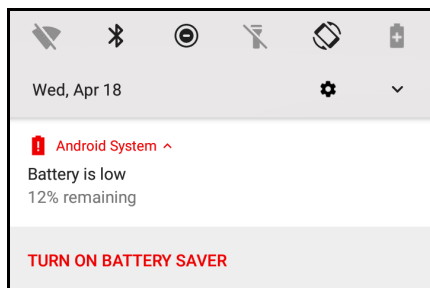
## Low Battery Notification

When the battery charge level drops below 18%, the device displays a notice to connect the device to power. The user should charge the battery using one of the charging accessories.

When the battery charge drops below 10%, the device displays a notice to connect the device to power. The user must charge the battery using one of the charging accessories.

When the battery charge drops below 4%, the device turns off. The user must charge the battery using one of the charging accessories.

Figure 17 Low Battery Notification



## Battery Optimization

Observe the following battery saving tips:

- Set the screen to turn off after a short period of non-use.
- Reduce screen brightness.
- Turn off all wireless radios when not in use.
- Turn off automatic syncing for Email, Calendar, Contacts, and other apps.
- Minimize use of apps that keep the device from suspending, for example, music and video apps.
- Enable Battery Saver mode. Swipe down from the Status bar and then touch **Battery saver**.

### Turning Off the Radios

To turn off all the radios:

1. Swipe down from the Status bar to open the Quick Settings panel.
2. Touch **Airplane mode**. The airplane icon ✈ appears in the Status bar indicating that all the radios are off.

### Setting the Date and Time

The date and time is automatically synchronized using an NITZ server when the device is connected to a wireless network. You are only required to set the time zone or set the date and time when not connected to a wireless network or if the wireless LAN does not support Network Time Protocol (NTP).

To set the date and time:

1. Swipe down from the Status bar to open the Quick Settings bar and then touch ⚙.
2. Touch **System > Date & time**.
3. Touch **Automatic date & time** to disable automatic date and time synchronization.
4. Touch **Automatic time zone** to disable automatic time zone synchronization.
5. Touch **Update Interval**.
6. Select the interval time to synchronize your device time from the network.
7. Touch **Set date**.
8. In the calendar, set today's date.
9. Touch **OK**.
10. Touch **Set time**.
11. Touch the green circle, drag to the current hour and then release.
12. Touch the green circle, drag to the current minute and then release.
13. Touch **AM** or **PM**.
14. Touch **OK**.
15. Touch **Select time zone**.
16. Select the current time zone from the list.
17. Touch **Use 24-hour format**.
18. Touch ○.

## Display Settings

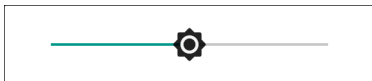
Use Display settings to change the screen brightness, enable night light, change the background image, enable screen rotation, set sleep time, and change font size.

### Setting the Screen Brightness


To manually set the screen brightness using the touchscreen:

1. Swipe down with two fingers from the Status bar to open the Quick Access panel.
2. Slide the icon to adjust the screen brightness level.

Figure 18 Brightness Slider




To let the device automatically adjust the screen brightness using the built-in light sensor:

1. Swipe down from the status bar to open the quick settings bar and then touch .
2. Touch **Display**.
3. If disabled, touch **Adaptive brightness** to automatically adjust the brightness.  
By default, **Adaptive brightness** is enabled. Toggle the switch to disable.
4. Touch .

### Setting Screen Timeout

To set the screen sleep time:

1. Swipe down from the Status bar to open the Quick Settings bar and then touch .
2. Touch **Display > Advanced > Sleep**.
3. Select one of the sleep values.
  - **15 seconds**
  - **30 seconds**
  - **1 minute** (default)
  - **2 minutes**
  - **5 minutes**
  - **10 minutes**
  - **30 minutes**.
4. Touch .

### Setting Font Size

To set the size of the font in system apps:


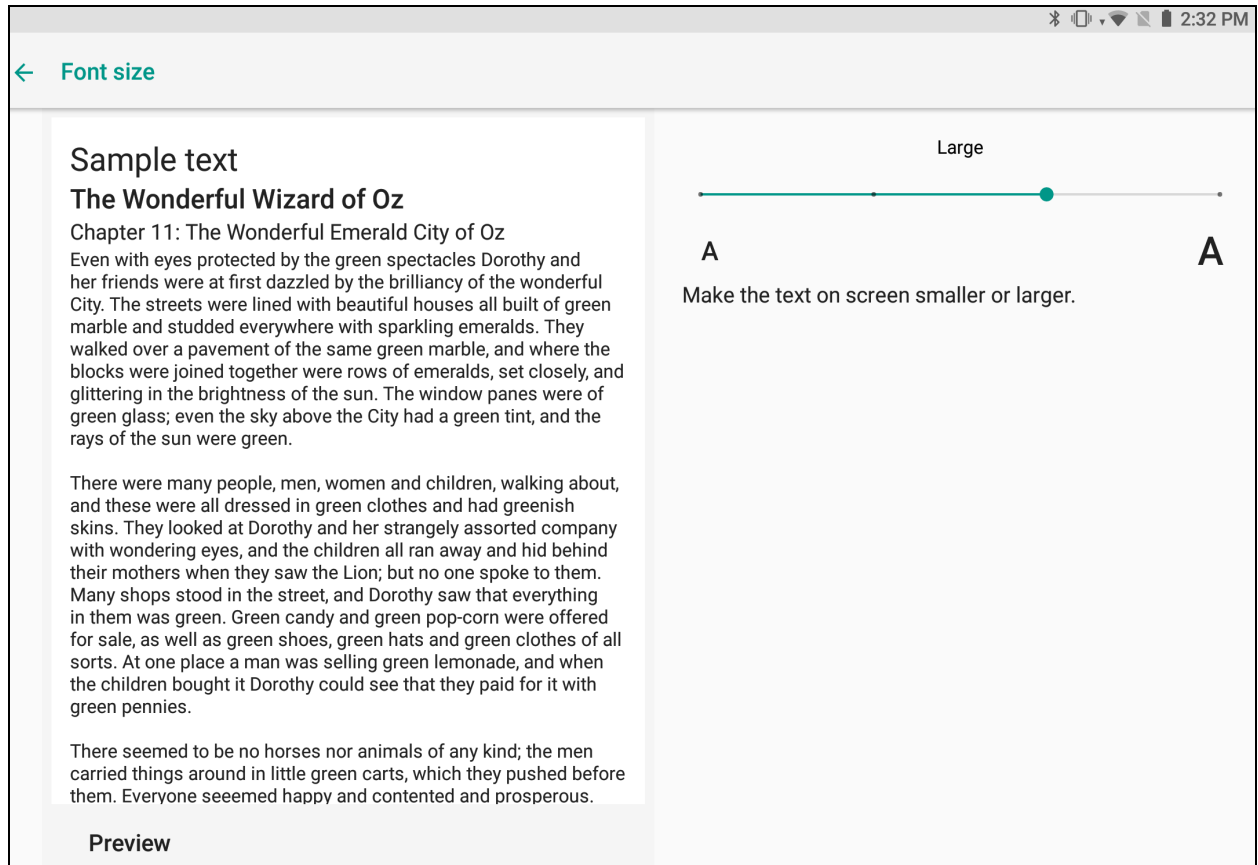

1. Swipe down from the Status bar to open the Quick Settings panel and then touch .
2. Touch **Display > Advanced**.
3. Touch **Font size**.

Figure 19 Font Settings




4. Select one of the font size values.
  - Small
  - Default
  - Large
  - Largest.
5. Touch .

## Setting Screen Rotation

By default, screen rotation is enabled.

To disable screen rotation:

1. Swipe down from the Status bar to open the Quick Settings bar and then touch .
2. Touch **Display > Advanced**.
3. Touch **Auto-rotate screen**.



**NOTE:** To change the Home screen rotation, see Setting Home Screen Rotation.

4. Touch .

## Touch Panel Mode

The device display is able to detect touches using a finger, a conductive-tip stylus, or gloved finger.



**NOTE:** A glove can be made of medical latex, leather, cotton, or wool. For optimal performance use a Zebra certified stylus.


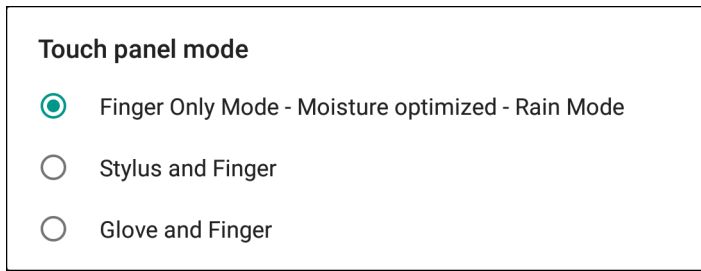
1. Swipe down from the Status bar to open the Quick Settings bar and then touch .
2. Touch **Display > Advanced**.
3. Touch **Touch panel mode**.

Figure 20 Touch Panel Mode Dialog Box



4. Select:
  - a. **Finger Only Mode - Moisture optimized - Rain Mode** to use a finger on the screen and when the device may have water on the screen.
  - b. **Stylus and Finger** to use a finger or a stylus on the screen.
  - c. **Glove and Finger** to use a finger or a gloved finger on the screen.
5. Touch .

## General Sound Setting

Use the **Sound** settings to configure media and alarm volumes.

To access sound settings:


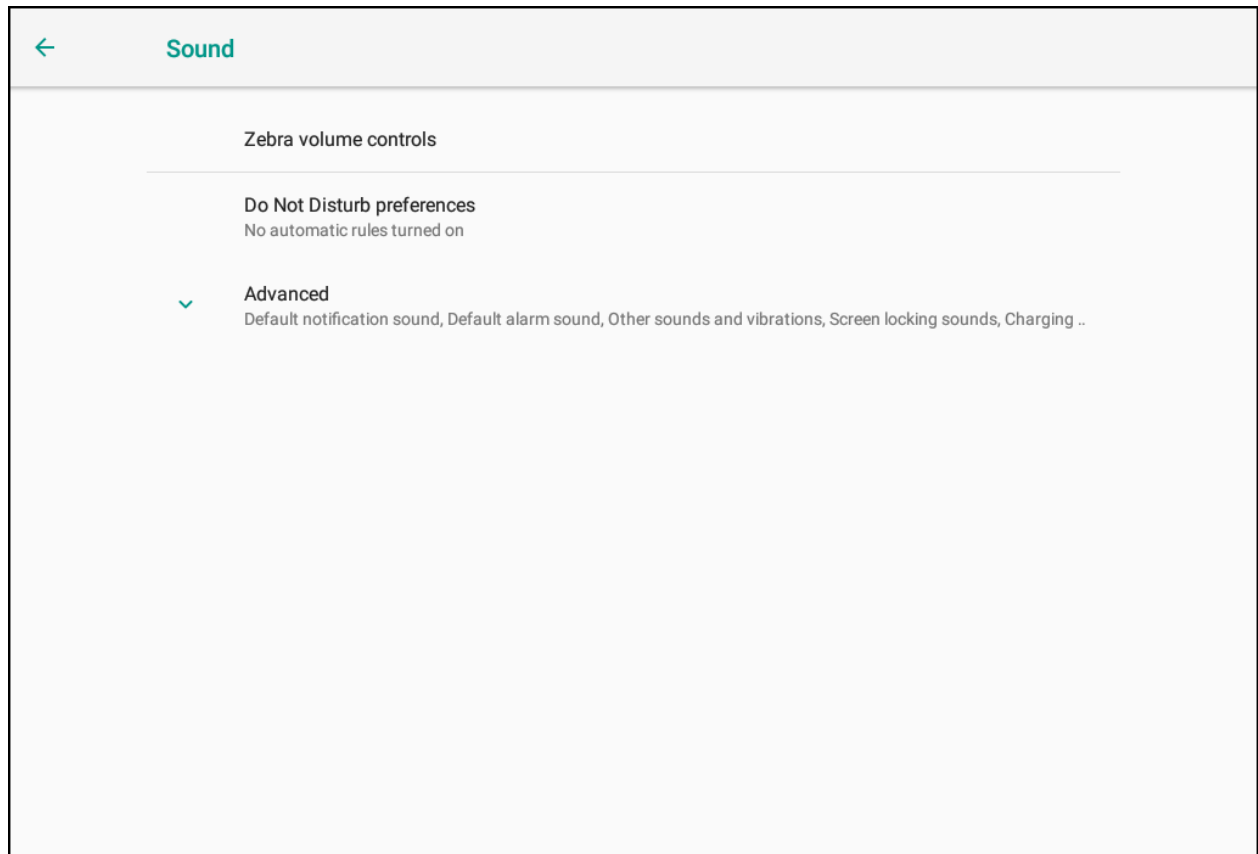



1. Swipe down from the Status bar to open the Quick Settings bar and then touch .
2. Touch **Sound**.
3. Touch an option to set sounds.

Figure 21 Sound Screen



- **Zebra volume controls**
  - **Ring volume** - Controls the ringtone volume.
  - **Media volume** - Controls the music, games, and media volume.
  - **Alarm volume** - Controls the alarm clock volume.
  - **Notifications volume** - Controls the notification volume.
  - **Scanner volume** - Controls the scanner volume.
  - **Volume presets**
    -  - Mutes the ring, notifications, and scanner so that the device does not make sounds or vibrate.
    -  - All sounds except media and alarms are silenced and vibrate mode is active.
    -  - Enables all sounds at the user defined levels.
- **Do Not Disturb preferences** - Mutes some or all sounds and vibrations.
  - **Priority only allows** - Use to set the priorities for the following:
    - **Reminders** - Switch on or off.
    - **Events** - Switch on or off.
    - **Alarms** - This is always enabled.
    - **Messages** - N/A.
    - **Calls** - N/A.
    - **Repeat callers** - N/A.
- **Block visual disturbances**



- **Block when screen is on** - This option prevents notifications from displaying over the screen (peeking) while you are actively using the device.
- **Block when screen is off** - This option prevents notifications from turning on the screen or pulsing the LED light when a new notification is received while you are not using the device.
- **Automatic rules** - Choose when to automatically silence the device. Touch a default rule, such as Weekend or Weeknight, or create your own rule. To create your own rule, tap **Add more** and then **Time rule**.
- **Advanced** - Touch to display advanced sound options.
  - **Default notification sound** - Touch to select a sound to play for all system notifications.
  - **Default alarm sound** - Touch to select a sound to play for alarms.
  - **Other sounds and vibrations**
    - **Screen locking sounds** - Play a sound when locking and unlocking the screen (default – enabled).
    - **Charging sounds** - Not applicable.
    - **Touch sounds** - Play a sound when making screen selections (default – enabled).
    - **Vibrate on tap** - Vibrate the device when making screen selections (default – disabled).
  - **Wireless emergency alerts** - Touch to configure emergency broadcast settings and notifications (ET56 only).

## Limit Sounds and Vibrations

Mute the device completely, or let through the important alarms or important calls.

### Total Silence

To completely mute the device so that it does not make a sound or vibrate, choose **Total silence**.


In Total silence mode:

- Alarms do not make noise.
- Device does not vibrate or make sounds when receiving a message, or notification.
- Sounds from music, videos, games, and other media are muted.



**NOTE:** All alarms are silenced in Total silence mode.

1. Swipe down with two fingers from the Status bar to open the Quick Access panel.
2. Touch **Do not disturb > Total silence**.
3. Choose **Until you turn it off** or select a time period.
4. Touch **Done**.

When Total Silence is on,  appears in the quick access panel and the Status bar.


To turn off Total Silence, open quick access panel and touch **Total silence**.

### Alarms Only

To mute the device so that you hear alarms, choose **Alarms only**. This option does not mute sounds from music, videos, games, or other media.

1. Swipe down with two fingers from the status bar to open the quick access panel.

2. Touch **Do not disturb > Alarms only**.
3. Choose **Until you turn it off** or select a time period.
4. Touch **Done**.

When Alarms Only is on,  appears in the quick access panel and the Status Bar.

To turn off Alarms Only, open the Quick Access panel and touch **Alarms only**.




**NOTE:** To quickly turn on Alarms Only, with the screen on, press and hold the Volume Down button until the volume is all the way down. Then, press Volume Down again to turn on Alarms Only.

To turn off Alarms Only, press either the Volume Up or Volume Down button and the touch **END NOW** in the alert message.

### Priority Notifications Only


To only be interrupted by important notifications, choose **Priority only**. This option does not mute sounds from music, videos, games, or other media.

Before turning on Priority Only mode, set the notification priorities:

1. Swipe down from the status bar to open the quick settings bar and then touch .
2. Touch **Sound > Do not disturb > Priority only allows**.
3. Set priorities.
  - **Alarms:** Disabled by default.
  - **Reminders** and **Events:** Switch on or off.
  - **Messages** and **Calls:** N/A.
  - **Repeat callers:** Choose whether to let the device ring if the same person calls again within 15 minutes.

After setting notification priorities, turn on Priority Only mode to limit interruptions. The priority notifications make a sound or vibrate based on the current ringer volume, but other notifications will be silenced.

1. Swipe down with two fingers from the status bar to open the quick access panel.
2. Touch **Do not disturb > Priority only**.
3. Choose **Until you turn it off** or select a time period.
4. Tap **Done**.

When Priority Only is on,  appears in the quick access panel and the Status Bar.


To turn off Priority Only, open quick access panel and touch **Priority only**.

### Automatically Block Sounds and Vibrations

Automatically silence the device during certain times or events, turn sounds back on, and override Do Not Disturb mode.

### Silence Sounds During Certain Times


To automatically silence the device during certain times, like at night or on weekends:

1. Swipe down from the Status bar to open the Quick Settings bar and then touch .



2. Touch **Sound > Do Not Disturb preferences**.
3. Touch a default **Weekend** or **Weeknight**. Or, to make a new rule, touch **Add more > Time rule**.
4. Enter a rule name.
5. Touch **OK**.
6. Edit the new rule:
  - **Rule name** - Rename the rule.
  - **Days, Start time, and End time** - Set the rule's schedule.
  - **Do Not Disturb preferences** - Choose whether the rule uses **Alarms only, Priority only, or Total silence**.
  - **Alarm can override end time** - Allow the alarm to continue to make sound until the next alarm begins.
7. Touch the On/Off switch at the top to turn on the rule.

## Silence Sounds During Events and Meetings

To automatically silence the device during events or meetings, set an event rule.

1. Swipe down from the Status bar to open the Quick Settings bar and then touch .
2. Touch **Sound > Do Not Disturb preferences**.
3. To edit the default rule, touch **Event**. Or, to create a new rule, touch **Add rule > Event rule**.
4. Edit the rule settings.
  - **Rule name** - Rename the rule.
  - **During events for** - Select which Google Calendar events the rule uses.
  - **Where reply is** - Set to: **Yes, Maybe, or Not replied, Yes or Maybe, or Yes**.
  - **Do Not Disturb preferences** - Choose whether the rule uses **Priority only, Alarms only, or Total silence**.
5. Touch the On/Off switch at the top to turn on the rule.

## Turn Sounds Back On


When the device is in Do Not Disturb mode, Alarms only or Priority only display as , or Total silence displays as .

To turn off Do Not Disturb, either:

- In the Quick Access panel, touch **Alarms only, Priority only, or Total silence**.
- Press the Volume Down button and touch **End Now**.

## Override Do Not Disturb for Specific Apps

To let through notifications from specific apps:

1. Swipe down from the Status bar to open the Quick Settings bar and then touch .
2. Touch **Apps & notifications > Notifications > App notifications**.

3. Touch an app.
4. Touch **Override Do Not Disturb**.

# Using the Tablet

## Introduction

This chapter describes the screens, status and notification icons, and controls on the tablet, and provides basic instructions for using the tablet

## Google Mobile Services



**NOTE:** This section applies to Google Mobile Services (GMS) devices only.

Devices with GMS contain apps and services that provide additional functionality.

GMS includes:

- Apps - GMS adds a variety of Google apps and associated widgets including Chrome, Gmail, Drive, and Maps.
- Services:
  - Speech to Text - Allows for free format speech to text in many languages for both connected and disconnected network. Launch by touching the microphone icon on the keyboard.
  - TalkBack Service - Provides spoken feedback on various parts of the user interface. To enable, go to **Settings > Accessibility**.
  - Network Location Provider - Adds a location provider which uses mobile network tower information and Wi-Fi access point information to provide a location without using GPS. To enable, go to **Settings > Security & location > Location**.
  - Google Cloud Messaging - Allows the device to receive data from the server and other devices on the same connection.
  - Backup and Restore - Allows the users settings and apps to be backed up to a Google server and subsequently restored from that server after a factory reset.
- Google Accounts - Create and use a Google account to synchronize mail, files, music, photos, contacts and calendar events.

## Home Screen

Turn on the device to display the Home screen. Depending on the configuration, the Home screen may appear different. Contact your system administrator for more information.

After a suspend or screen time-out, the Home screen displays with the lock slider. Touch the screen and slide up to unlock. For screen locking information, see Un-Locking the Screen.

The Home screen provides additional screens for placement of widgets and shortcuts. Swipe the screen left or right to view the additional screens.

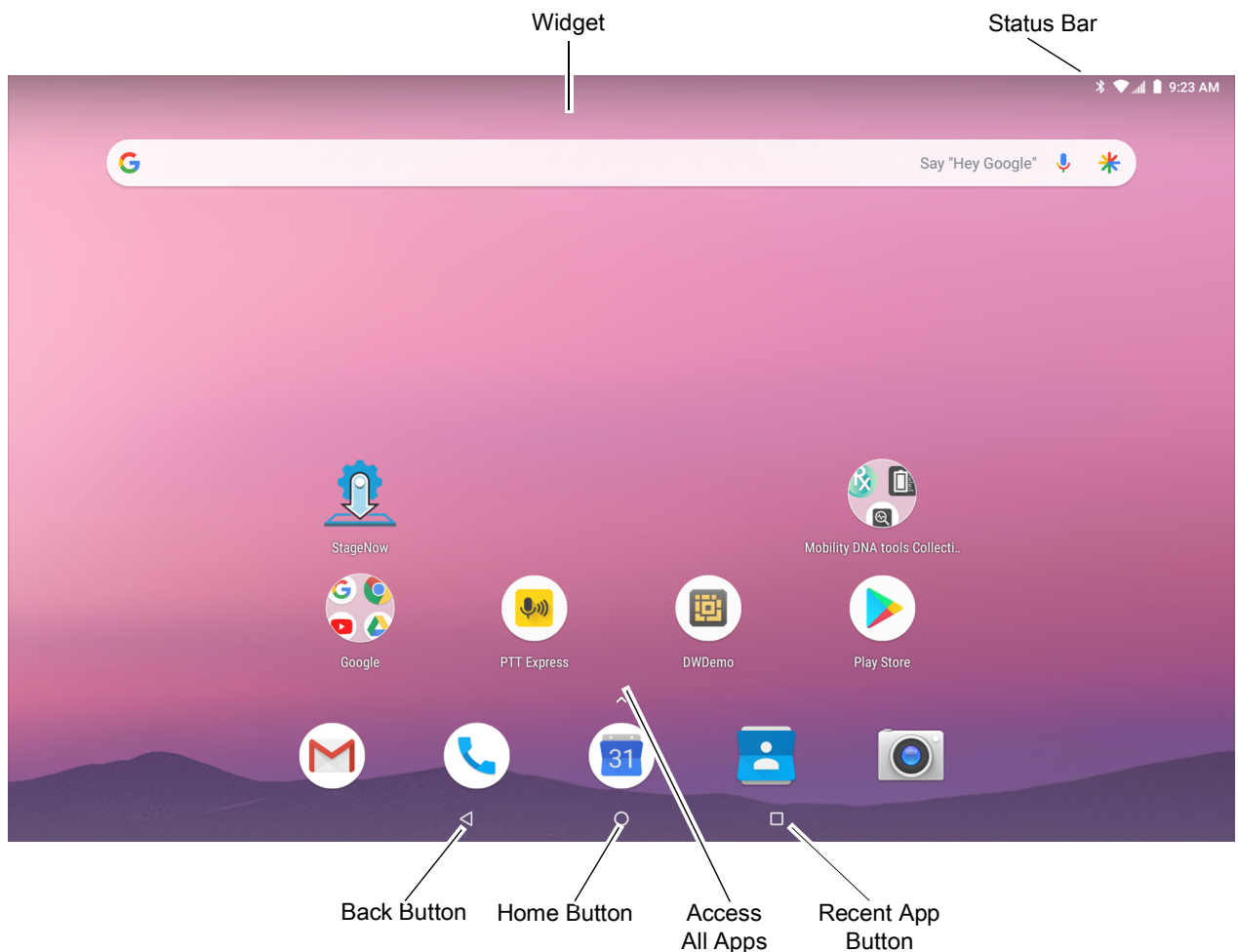


**NOTE:** By default, non-GMS devices do not have the same icons on the Home screen as GMS. Icons are shown below for example only.

Home screen icons can be configured by the user and may look different than shown.

## Home Screen

Figure 22 Home Screen - ET56 Shown



## Status Bar

The Status bar displays the time, notification icons (left side), and status icons (right side).



**NOTE:** Some Status icons may not appear in the Status bar if there are too many icons to display.

**Figure 23** Notification and Status Icons



If there are more notifications than can fit in the Status bar, two dots display indicating that more notifications exist. Swipe down from the Status bar to open the Notification panel and view all notifications and status.









## Status Icons

**Table 7** Status Icons

Icon	Description
	Alarm is active.
	Main battery is fully charged.
	Main battery is partially drained.
	Main battery charge is low.
	Main battery charge is very low.
	Main battery is charging.
	Indicates that the optional Power Pack is fully charged.
	Indicates that the optional Power Pack is partially drained.
	Indicates that the optional Power Pack charge is low.
	Indicates that the optional Power Pack charge is very low.
	Indicates that the optional Power Pack is charging when in charging cradle.
	All sounds, except media and alarms, are silenced and vibrate mode is active.
	Do Not Disturb mode active.
	Airplane Mode is active. All radios are turned off.
	Bluetooth is on.
	The device is connected to a Bluetooth device.
	Connected to a Wi-Fi network.

<sup>1</sup>Cellular network icon that appears is dependent upon the carrier/network.










**Table 7** Status Icons (Continued)

Icon	Description
	Not connected to a Wi-Fi network or no Wi-Fi signal.
	Connected to an Ethernet network.
	Speakerphone enabled.
	Portable Wi-Fi hotspot is active (WWAN only).
	Indicates that all sounds except media and alarms are silenced.
	Connected to a 4G LTE/LTE-CA network (WWAN only) <sup>1</sup> .
<b>4G</b>	Connected to a DC-HSPA, HSDPA, HSPA+, HSUPA, LTE/LTE-CA or WCDMA network (WWAN only) <sup>1</sup> .
<b>3G</b>	Connected to a 1x-RTT (Sprint), EGDGE, EVDO, EVDV or WCDMA network (WWAN only) <sup>1</sup> .
<b>1X</b>	Connected to a 1x-RTT (Verizon) network (WWAN only) <sup>1</sup> .
	Roaming from a network (WWAN only).
	No SIM card installed (WWAN only).

<sup>1</sup>Cellular network icon that appears is dependent upon the carrier/network.










## Notification Icons

**Table 8** Notification Icons

Icon	Description
	Main battery is low.
<b>..</b>	More notifications are available for viewing.
	Data is syncing.
	Indicates an upcoming event. Non-GMS devices only.
	Indicates an upcoming event. GMS devices only.
	Open Wi-Fi network is available.
	Song is playing.
	Problem with sign-in or sync has occurred.
	Device is uploading data.
	Device is downloading data when animated and download is complete when static.



**Table 8** Notification Icons (Continued)

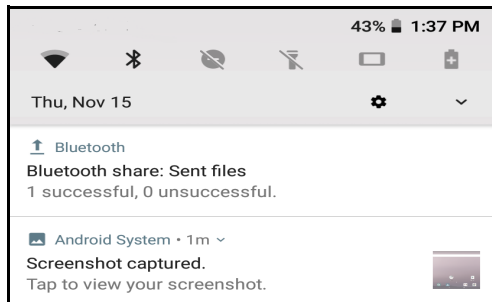
Icon	Description
	Device is connected via USB cable.
	Device is connected to or disconnected from virtual private network (VPN).
	Preparing internal storage by checking it for errors.
	USB debugging is enabled on the device.
	Headset is connected to the device.
	PTT Express Voice client status. See the PTT Express PTT Notification Icons for a complete list.
	Indicates that RxLogger app is running.
	Indicates the RS507x/RS6000 is connected to the device.
	Indicates the RS507 or RS507x/RS6000 is connected to the device in HID mode.

## Managing Notifications

Notification icons report the arrival of new messages, calendar events, alarms, and ongoing events. When a notification occurs, an icon appears in the Status bar with a brief description. See Notification Icons for a list of possible notification icons and their description. Open the Notification panel to view a list of all the notifications.

To open the Notification panel, drag the Status bar down from the top of the screen.

**Figure 24** Notification Panel



To respond to a notification, open the Notification panel and then touch a notification. The Notification panel closes and the corresponding app opens.

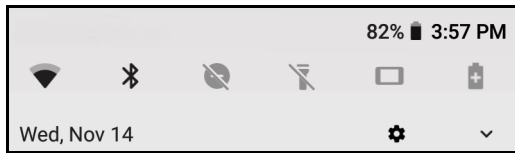
To clear all notifications, open the Notification panel and then touch **CLEAR ALL**. All event-based notifications are removed. Ongoing notifications remain in the list.

To close the Notification panel, swipe the Notification panel up.

## Quick Access Panel

Use the Quick Access panel to access frequently used settings (for example, Airplane mode).

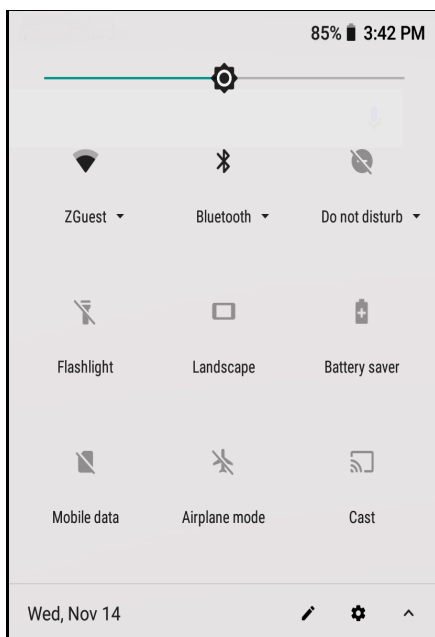
**Figure 25** Quick Settings Bar



To see the full Quick Access panel:

- If the device is locked, swipe down once.
- If the device is unlocked, swipe down once with two fingers, or twice with one finger.
- If the Quick Settings bar is open, touch the Down arrow.

**Figure 26** Quick Access Panel



**NOTE:** Not all icons are pictured. Icons may vary.

To change a setting, touch the icon:

- Display brightness - Use the slider to decrease or increase the brightness of the screen.
- Wi-Fi network - Turn Wi-Fi on or off. To open Wi-Fi settings, touch the Wi-Fi network name.
- Bluetooth settings - Turn Bluetooth on or off. To open Bluetooth settings, touch **Bluetooth**.
- Battery saver - Turn Battery saver mode on or off. When Battery saver mode is on the performance of the device is reduced to preserve battery power.
- Invert colors - Invert the display colors.
- Do not disturb - Control how and when to receive notifications.
- Mobile data - Turns cellular radio on or off. To open Mobile data settings, touch and hold (ET56 only).
- Airplane mode - Turn Airplane mode on or off. When Airplane mode is on the device does not connect to Wi-Fi or Bluetooth.
- Auto-rotate - Lock the device's orientation in portrait or landscape mode or set to automatically rotate.
- Flashlight - Turn flashlight on or off. Turn camera flash on or off.

- Location - Enable or disable locationing feature.
- Hotspot - Turn on to share the device's mobile data connection with other devices.
- Data Saver - Turn on to prevent some apps from sending or receiving data in the background.
- Night Light - Tint the screen amber to make it easier to look at the screen in dim light. Set Night Light to turn on automatically from sunset to sunrise, or at other times.
- Cast - Share phone content on Chromecast or a television with Google Cast built-in. Touch cast screen to display a list of devices, then touch a device to begin casting.

## App Shortcuts and Widgets

App shortcuts placed on the Home screen allow quick and easy access to apps. Widgets are self-contained apps placed on the Home screen to access frequently used features.

### Adding an App Shortcut to the Home Screen

To add an app shortcut to the Home screen:

1. Go to the desired Home screen.
2. Swipe up from the bottom of the screen.
3. Scroll through the list to find the app icon.
4. Touch and hold the icon until the Home screen appears.
5. Position the icon on the screen and then release.

### Adding a Widget to the Home Screen

To add a widget to the Home screen:

1. Go to the desired Home screen.
2. Touch and hold until the menu appears.
3. Touch **WIDGETS**.
4. Scroll through the list to find the widget.
5. Touch and hold the widget until the Home screen appears.
6. Position the widget on the screen and then release.

### Moving Items on the Home Screen

To move app shortcuts or widgets on the Home screen:

1. Touch and hold the item until it floats on the screen.
2. Drag the item to a new location. Pause at the edge of the screen to drag the item onto an adjacent Home screen.
3. Lift finger to place the item on the Home screen.

### Removing an App Shortcut or Widget from the Home Screen

To remove an app shortcut or widget from the Home screen:

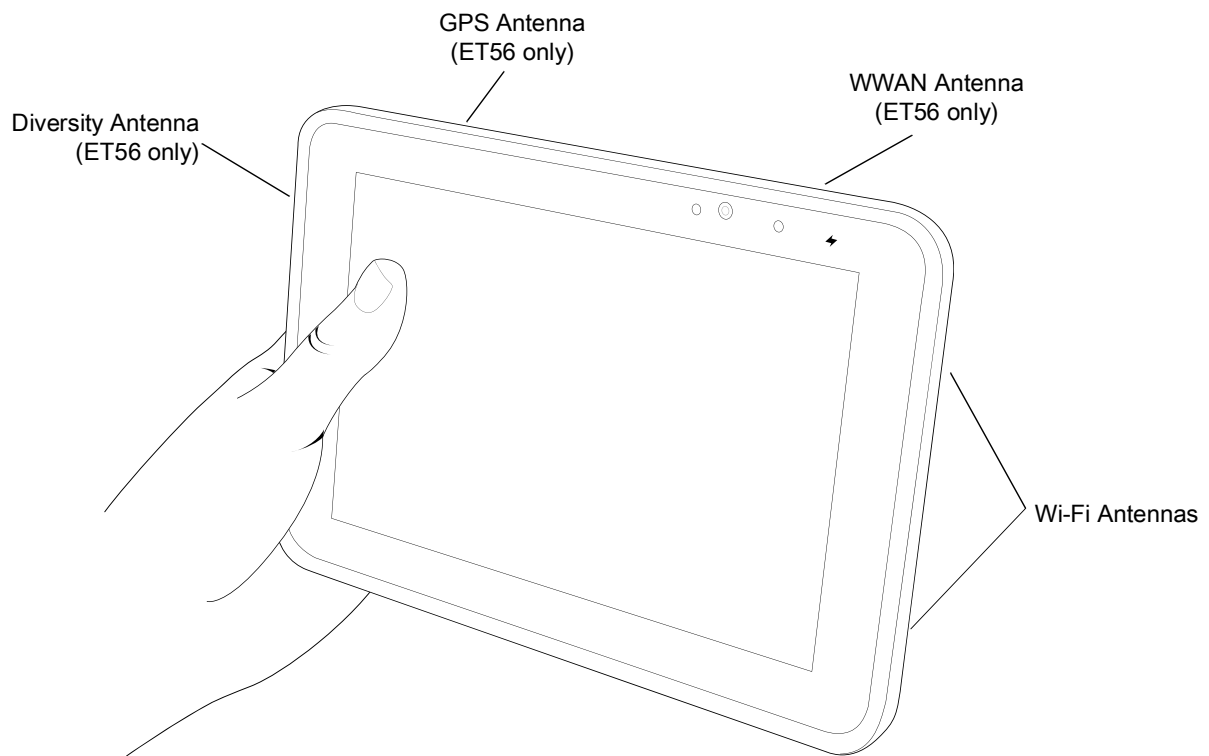
1. Go to the desired Home screen.
2. Touch and hold the app shortcut or widget icon until it floats on the screen.
3. Drag the icon to **X Remove** at the top of the screen and then release.

### Folders

Use **Folders** to organize similar applications together. Tap the folder to open and display items in the folder.

### Holding the Device

For optimal wireless performance avoid covering the internal antennas with hands or other objects. Use of Expansion Back is recommended.



### Using the Touchscreen

Use the multi-tap sensitive screen to operate the device.


- Tap - Tap to:
  - Select items on the screen.
  - Type letters and symbols using the on-screen keyboard.
  - Press on-screen buttons.

- Tap and Hold - Tap and hold:
  - An item on the Home screen to move it to a new location or to the trash.
  - An item in Apps to create a shortcut on the Home screen.
  - The Home screen to open a menu for customizing the Home screen.
  - An empty area on the Home screen until the menu appears.
- Drag - Tap and hold an item for a moment and then move finger on the screen until reaching the new position.
- Swipe - Move finger up and down or left and right on the screen to:
  - Unlock the screen.
  - View additional Home screens.
  - View additional app icons in the Launcher window.
  - View more information on an app's screen.
- Double-tap - Tap twice on a web page, map, or other screen to zoom in and out.
- Pinch - In some apps, zoom in and out by placing two fingers on the screen and pinching them together (to zoom out) or spreading them apart (to zoom in).

## Keyboard Configuration



### Enabling Keyboards

To enable keyboards:

1. Swipe down from the Status bar to open the Quick Settings bar and then touch .
2. Touch **System > Languages & input > Virtual keyboard > Manage keyboards**.
3. Touch a keyboard to enable.

### Switching Between Keyboards

To switch between keyboards, touch in a text box to display the current keyboard.

- On the Android or Gboard keyboards, touch and hold .
- On the Enterprise keyboard, touch .

### Editing Text

Edit entered text and use menu commands to cut, copy, and paste text within or across apps. Some apps do not support editing some or all of the text they display; others may offer their own way to select text.

### Entering Numbers, Symbols, and Special Characters

To enter numbers and symbols:

- Touch and hold one of the top-row keys until a menu appears then select a number or special character.
- Touch the Shift key once for a single capital letter. Touch the Shift key twice to lock in uppercase. Touch the Shift key a third time to unlock Capslock.
- Touch **?123** to switch to the numbers and symbols keyboard.
- Touch the **=\<** key on the numbers and symbols keyboard to view additional symbols.

To enter special characters, touch and hold a number or symbol key to open a menu of additional symbols. A larger version of the key displays briefly over the keyboard.










## Apps

The **APPS** screen displays icons for all installed apps. The table below lists the apps installed on the device. Refer to the ET51/56 Integrator Guide for Android Version 8.1.0 for information on installing and uninstalling apps.











**Table 9** Apps

Icon	Description
	<b>Battery Manager</b> - Displays battery information, including charge level, status, health and wear level.
	<b>Bluetooth Pairing Utility</b> – Use to pair a Bluetooth Imager with the device by scanning a barcode.
	<b>Calculator</b> - Provides the basic and scientific arithmetic functions.
	<b>Calendar</b> - Use to manage events and appointments. GMS/GMS-Restricted only.
	<b>Camera</b> - Take photos or record videos. For more information see Camera.
	<b>Chrome</b> - Use to access the Internet or intranet. GMS/GMS-Restricted only.
	<b>Clock</b> - Use to schedule alarms for appointments or as a wake-up.
	<b>Contacts</b> - Use to manage contact information. See Contacts for more information.
	<b>DataWedge</b> - Enables data capture using the imager.
	<b>Device Central</b> - Use to display detailed information about the device and connected peripherals. See Device Central for more information.
	<b>Diagnostic Tool</b> - Use to diagnose the device.

Table 9 Apps (Continued)

Icon	Description
	<b>Drive</b> - Upload photos, videos, documents, and other files to personal storage site. GMS/GMS-Restricted only.
	<b>Duo</b> - A one-to-one video calling app (WWAN only). GMS/GMS-Restricted only.
	<b>DWDemo</b> - Provides a way to demonstrate the data capture features using the imager. See DataWedge Demonstration for more information.
	<b>Files</b> - Organize and manage files on the device.
	<b>Gmail</b> - Use to send and receive email using a Google email account. GMS/GMS-Restricted only.
	<b>Google</b> - Launches Google™ search app. GMS/GMS-Restricted only.
	<b>Hangouts</b> - Use to communicate with friends using text messages and photos. GMS/GMS-Restricted only.
	<b>Keep Notes</b> - Use to create, edit, and share notes. GMS/GMS-Restricted only.
	<b>License Manager</b> - Use to manage software licenses on the device.
	<b>Maps</b> - Use to see your location on a map (with public transit, traffic, or satellite overlays). Search for any business or place of interest. Provides turn-by-turn navigation with voice guidance, traffic-avoidance, and alternate routes, for drivers, cyclists, walkers, and users of public transportation. GMS/GMS-Restricted only.
	<b>MSRN</b> - Use to verify authenticity of the paired Snap-on MSR and to provision the Snap-on MSR.
	<b>Phone</b> - Use to dial a phone number when used with some Voice over IP (VoIP) clients (VoIP telephony ready only).
	<b>Photos</b> - Use to sync photos with Google account. For more information, see <a href="#">Photos on page 75</a> . GMS/GMS-Restricted only.
	<b>Play Movies &amp; TV</b> - View movies and video on your device. GMS/GMS-Restricted only.

**Table 9** Apps (Continued)

Icon	Description
	<b>Play Music</b> - Use to listen to music. GMS/GMS-Restricted only.
	<b>Play Store</b> - Download music, movies, books, and Android apps and games from the Google Play Store. GMS/GMS-Restricted only.
	<b>RxLogger</b> - Use to diagnose device and app issues. Refer to the ET51/56 Integrator Guide for Android Version 8.1.0 for more information.
	<b>RxLogger Utility</b> - Use to view, backup, and archive RxLogger data. Refer to the ET51/56 Integrator Guide for Android Version 8.1.0 for more information.
	<b>Settings</b> - Use to configure the device.
	<b>Sound Recorder</b> - Use to record audio.
	<b>StageNow</b> - Allows the device to stage a device for initial use by initiating the deployment of settings, firmware, and software.
	<b>Worry Free Wifi Analyzer</b> - A diagnostic intelligent app. Use to diagnose surrounding area and display network stats, such as coverage hole detection, or AP in vicinity. Refer to the Worry Free Wi-Fi Analyzer Administrator Guide for Android.
	<b>YouTube</b> - Use to view videos on the YouTube™ web site. GMS/GMS-Restricted only.
	<b>Zebra Bluetooth</b> - Use to configure Bluetooth logging.

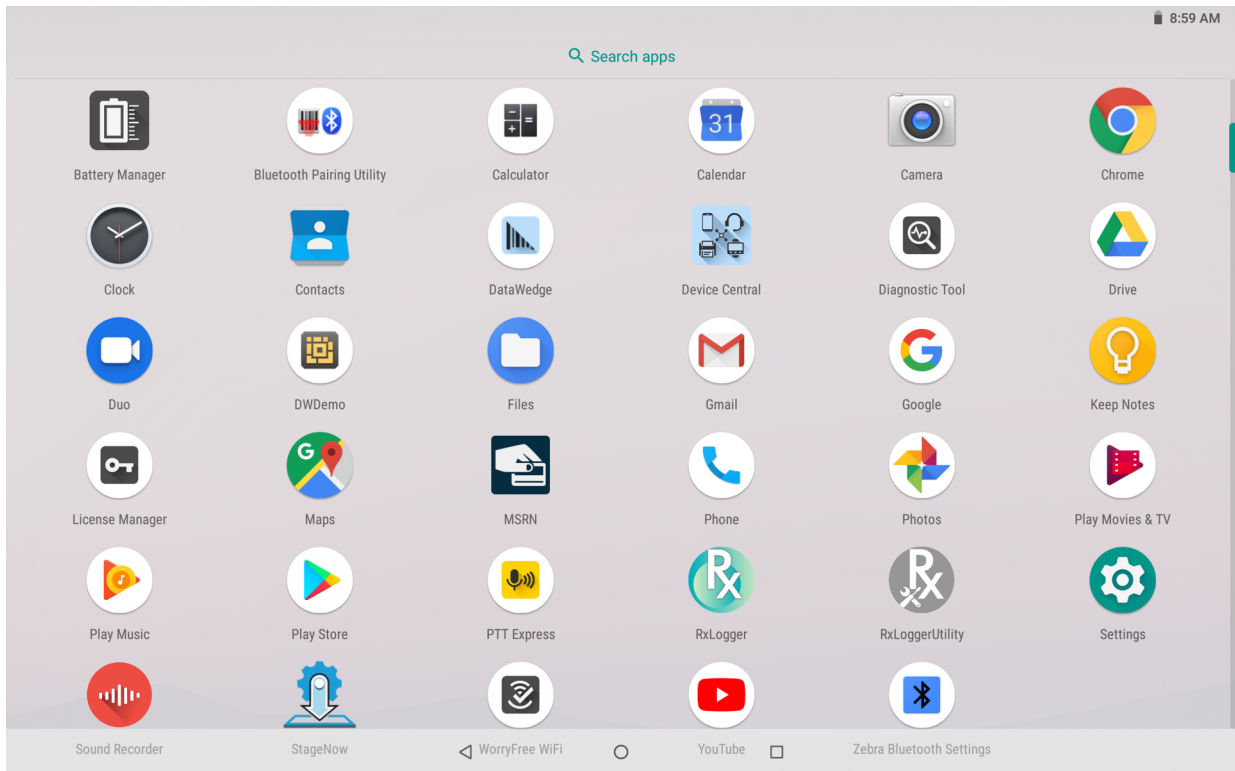
## Accessing Apps

All apps installed on the device are accessed using the **APPS** window.

1. On the Home screen, swipe up from the bottom of the screen.




**Figure 27** APPS Window Example



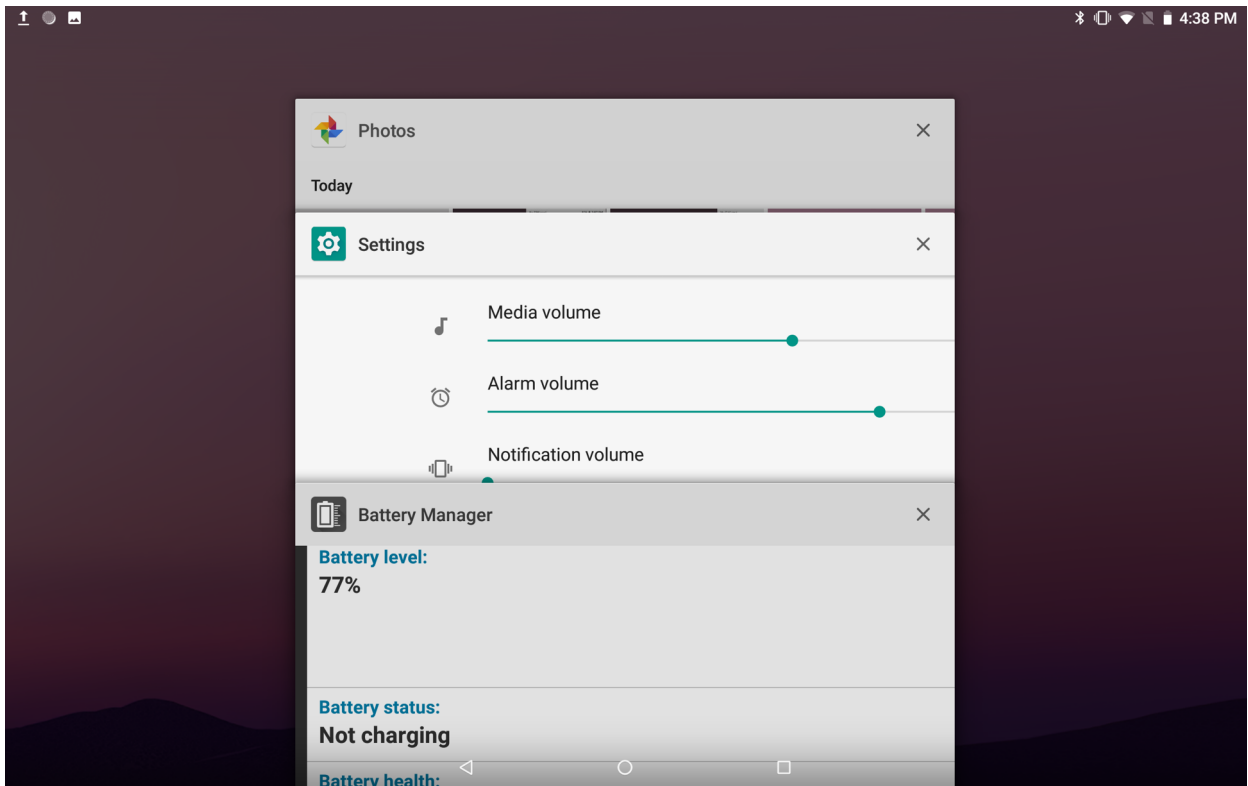
Slide the **APPS** window up or down to view more app icons. Touch an icon to open the app.

## Switching Between Recent Apps

To switch between recent apps:

1. Touch . A window appears on the screen with icons of recently used apps.

**Figure 28** Recently Used Apps



2. Slide the apps displayed up and down to view all recently used apps.
3. Swipe left or right to remove app from the list and force close the app.
4. Touch an icon to open an app or touch ◀ to return to the current screen.

## Un-Locking the Screen

Use the Lock screen to protect access to data on the device. Some email accounts require locking the screen. Refer to the device Integrator Guide for information on setting up the locking feature.

When locked, a pattern, PIN, or password is required to unlock the device. Press the Power button to lock the screen. The device also locks after a pre-defined time-out.

Press and release the Power button to wake the device. The Lock screen displays. Swipe the screen up to unlock. If the Pattern screen unlock feature is enabled, the Pattern screen appears instead of the Lock screen. If the PIN or Password screen unlock feature is enabled, enter the PIN or password after unlocking the screen.

Figure 29 Lock Screen

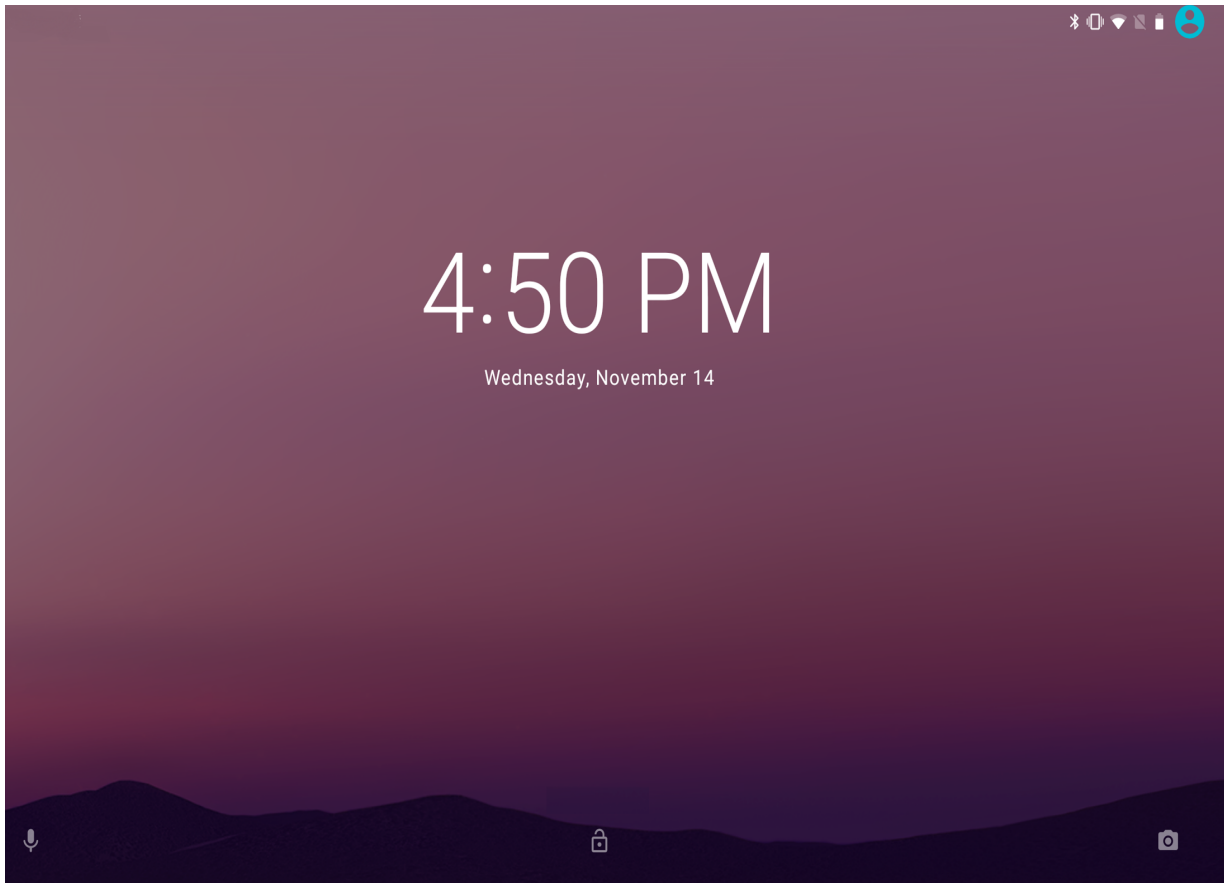


Figure 30 PIN Screen

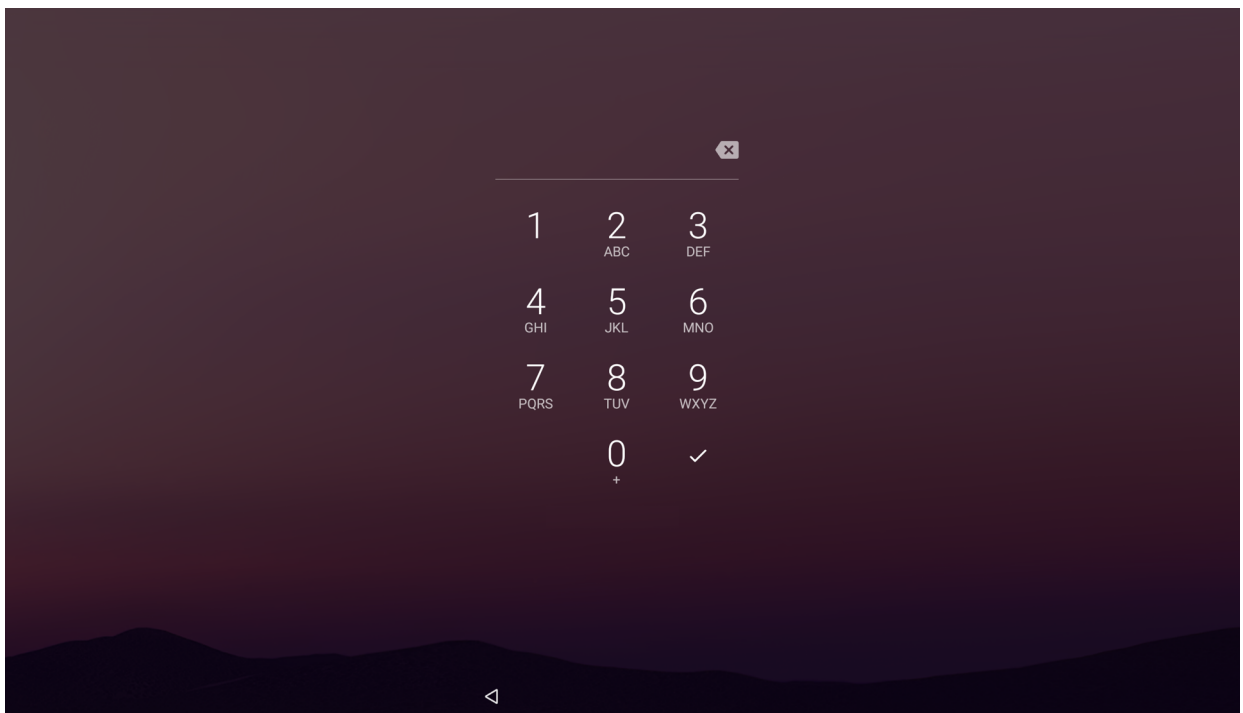


Figure 31 Pattern Screen

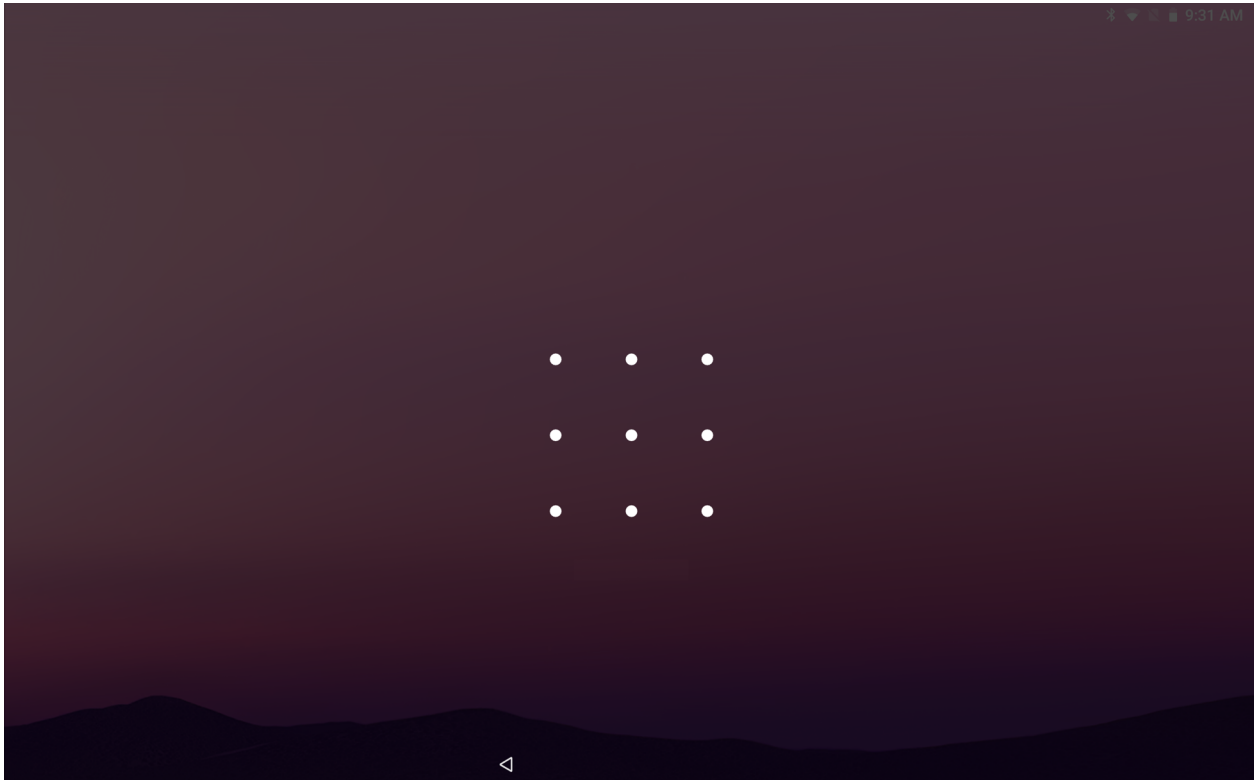
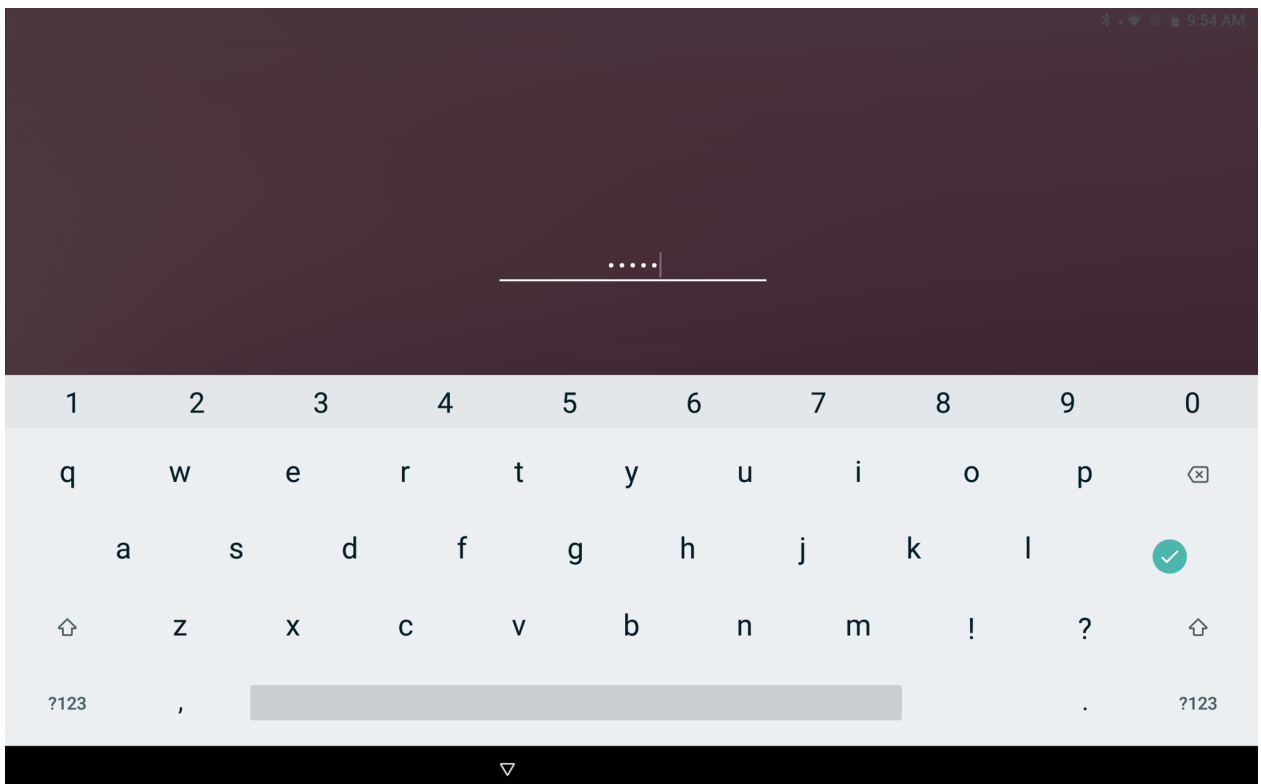


Figure 32 Password Screen



## Suspend Mode

The device goes into suspend mode when you press the PowerScan button, or any of the configured wake-up sources (Center Scan or Gun Trigger), or after a period of inactivity (set in the Display settings window) (if the **Never** setting is changed to something else in **Settings > Display > Advanced > Sleep**).

To wake the device from Suspend mode, press the PowerScan button. The Lock screen displays. Swipe the screen up to unlock. If the Pattern screen unlock feature is enabled, the Pattern screen appears instead of the Lock screen. If the PIN or Password screen unlock feature is enabled, enter the PIN or password after unlocking the screen. See Un-Locking the Screen.



**NOTE:** If you enter the PIN, password, or pattern incorrectly five times, you must wait 30 seconds before trying again. If you forget the PIN, password, or pattern contact your system administrator.

## Resetting the Device

The reset functions include the following:

- Soft reset
- Hard reset
- Enterprise reset - Refer to the device Integrator Guide for more information.
- Factory reset - Refer to the device Integrator Guide for more information.
- Full Factory reset.

### Performing a Soft Reset

Perform a soft reset if applications stop working.

1. Press and hold the soft Power button until the menu appears.
2. Touch **Restart**.  
The device reboots.

### Performing a Hard Reset



**CAUTION:** Performing a hard reset with a microSD card installed in the device may cause damage or data corruption to the microSD card. All un-saved data is lost after performing a hard reset.

Perform a hard reset if the device stops responding.

1. Press and hold the power button and the volume up button.
2. When the screen turns off, release the buttons.  
The device reboots.

# Applications

## Introduction

This chapter describes the apps installed on the device.

## Battery Manager

The **Battery Manager** provides detailed information about the battery.


To open Battery Manager, swipe up from the bottom of the Home screen and touch .

Figure 33 Battery Manager Screen

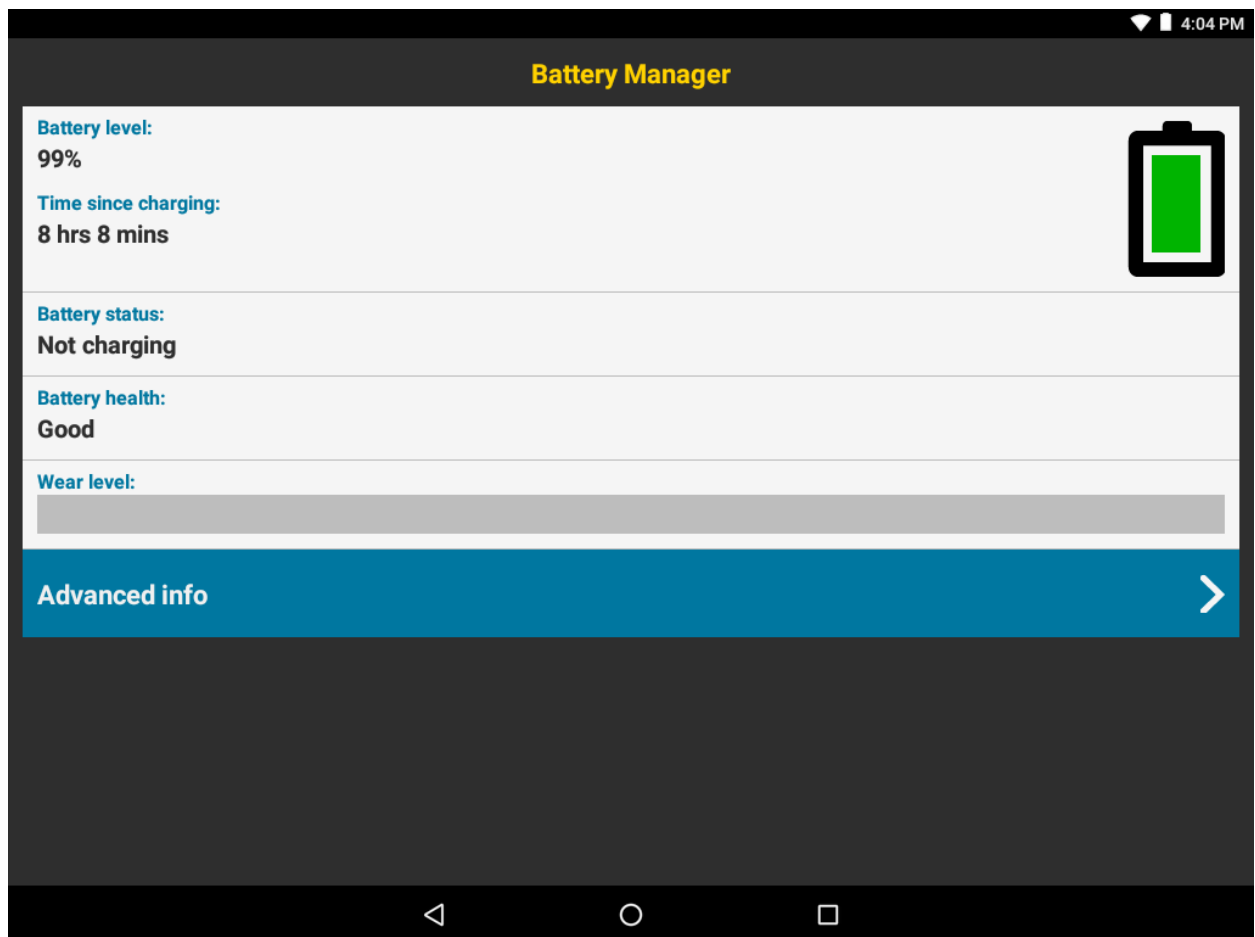






Table 10 Battery Icon Description

Battery Icon	Description
	Battery charge level.
	Battery charging.
	Battery charge level is below 20%.

- **Battery level** - The current battery charge level as a percentage. Displays -% when level is unknown.
- **Time until full** - The amount of time until the battery is fully charged.
- **Time since charging** - The amount of time since the device began charging.
- **Time until empty** - The amount of time until the battery is empty.
- **Battery status**
  - **Not charging** - The device is not connected to AC power charging.
  - **Charging over AC** - The device is connected to AC power and charging.
  - **Charging over USB** - The device is connected to a host computer with a USB cable and charging.
  - **Discharging** - That the battery is discharging.
  - **Full** - That the battery is fully charged.
  - **Unknown** - The battery status is unknown.
- **Battery health** - The health of the battery. If a critical error occurs,  appears. Touch to view the error description.
  - **Decommission** - The battery is past its useful life and should be replaced. See system administrator.
  - **Good** - The battery is good.
  - **Charge error** - An error occurred while charging. See system administrator.
  - **Over Current** - An over-current condition occurred. See system administrator.
  - **Dead** - The battery has no charge. Replace the battery.
  - **Over Voltage** - An over-voltage condition occurred. See system administrator.
  - **Below Temperature** - The battery temperature is below the operating temperature. See system administrator.
  - **Failure Detected** - A failure has been detected in the battery. See system administrator.
  - **Unknown** - See system administrator.
- **Wear level** - The health of the battery in graphical form. When the wear level exceeds 80%, the bar color changes to red.

- **Advanced info** - Touch to view additional battery information.
  - **Battery present status** - Indicates that the battery is present.
  - **Battery level** - The battery charge level as a percentage of scale.
  - **Battery scale** - The battery scale level used to determine battery level (100).
  - **Battery voltage** - The current battery voltage in millivolts.
  - **Battery temperature** - The current battery temperature in degrees Centigrade.
  - **Battery technology** - The type of battery.
  - **Battery current** - The average current into or out of the battery over the last second in mAh.
  - **Battery manufacture date** - The date of manufacture.
  - **Battery serial number** - The battery serial number. The number matches the serial number printed on the battery label.
  - **Battery part number** - The battery part number.
  - **Battery rated capacity** - Lists the rated capacity of the backup battery in mAh.
  - **Battery decommission status** - Indicates if the battery is past its life span.
    - **Battery Good** - The battery is in good health.
    - **Decommissioned Battery** - The battery is past its useful life and should be replaced.
  - **Base cumulative charge** - Cumulative charge using Zebra charging equipment only.
  - **Battery present capacity** - Maximum amount of charge that could be pulled from the battery under the present discharge conditions if the battery were fully charged.
  - **Battery usage number** - The health of the battery as a result of charging and discharging. A high number indicates low battery health.
  - **Battery error status** - The error status of the battery.
  - **App version** - The application version number.



## Camera

This section provides information for taking photos and recording videos using the integrated digital cameras.



**NOTE:** The device saves photos and videos on the microSD card, if installed and the storage path is changed manually. By default, or if a microSD card is not installed, the device saves photos and videos on the internal storage. The device saves photos and videos on the internal storage.

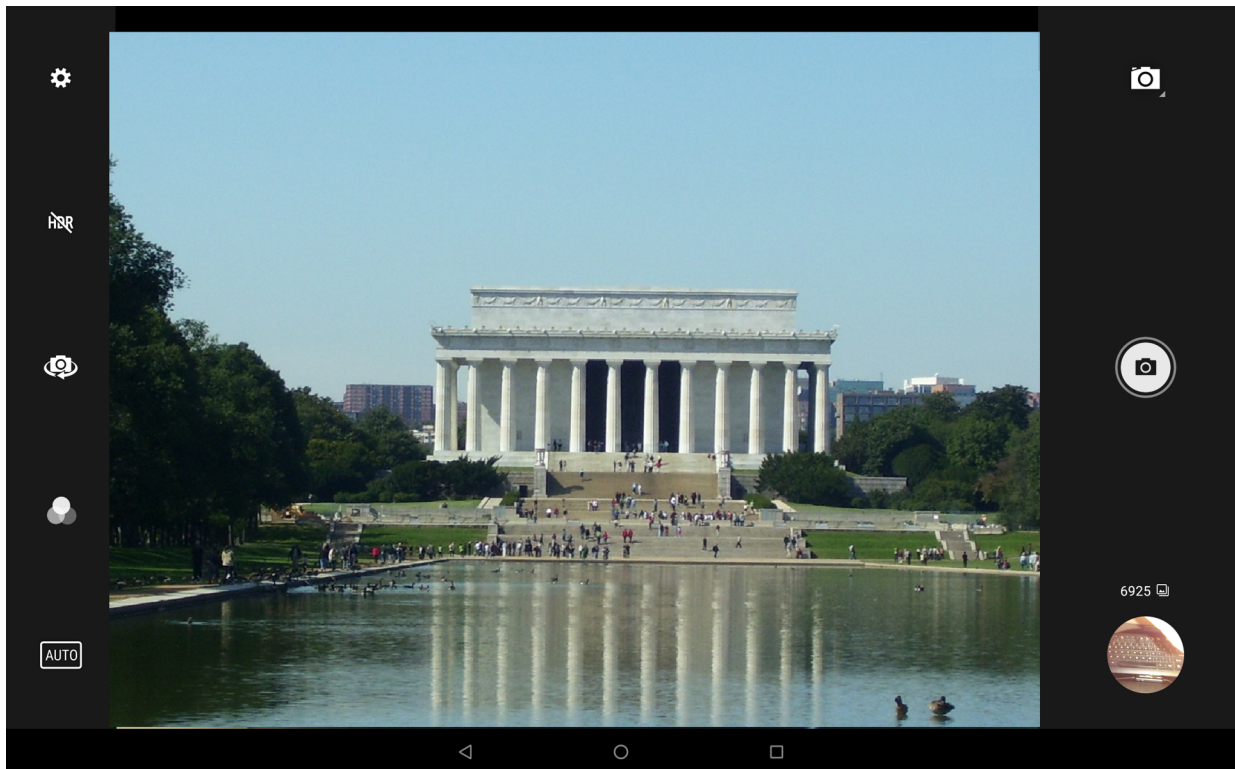
## Taking Photos





**NOTE:** See Photo Settings for camera setting descriptions.

1. Swipe up from the bottom of the Home screen and touch **Camera**.

Figure 34 Camera Mode



2. If necessary, touch the Camera Mode icon and touch .
3. Frame the subject on the screen.
4. To zoom in or out, press two fingers on the display and pinch or expand fingers. The zoom controls appear on the screen.
5. Touch an area on the screen to focus. The focus circle appears. The two bars turn green when in focus.
6. Touch .
 

The camera takes a photo and a shutter sound plays.

The photo momentarily displays as a thumbnail in the lower left corner.

## Recording Videos


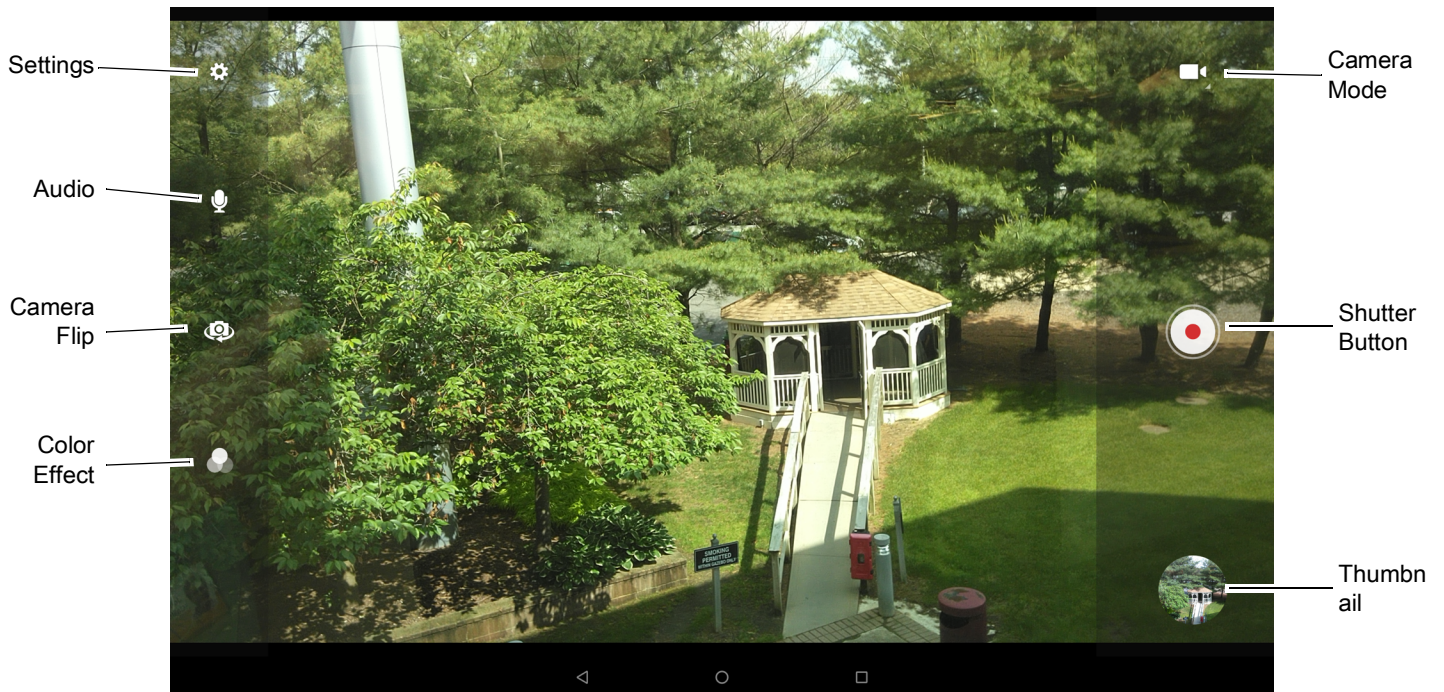


1. Swipe up from the bottom of the Home screen and touch **Camera**.
2. Touch the camera mode menu and touch .


Figure 35 Video Mode

3. Point the camera and frame the scene.



4. To zoom in or out, press two fingers on the display and pinch or expand fingers. The zoom controls appear on the screen.
5. Touch  to start recording.  
The video time remaining appears in the top left of the screen.
6. Touch  to the end recording.  
The video momentarily displays as a thumbnail in the lower left corner.






## Photo Settings

In Photo mode, photo settings appear on screen. Touch  to display the photo settings options.




### Front Camera






- **Selfie Flash** - Turns screen white to help produce a little extra light in dimmer settings. Options: **Off** (default), or **On**.
- **GPS location** - Add GPS location information to the photo meta-data. Options: **On** or **Off** (default). ET56 only.
- **Picture size** - Set the size (in pixels) of the photo to: **5M pixels** (default), **3M pixels**, **HD1080**, **2M pixels**, **HD720**, **1M pixels**, **WVGA**, **VGA**, or **QVGA**.

## Applications


- **Picture quality** - Set picture quality setting to: **Low**, **Standard** (default) or **High**.
- **Countdown timer** - Set to: **Off** (default), **2 seconds**, **5 seconds** or **10 seconds**.
- **Storage** – Set location to store the photo to: **Phone** or **SD Card**.
- **Face Detection** - Select to turn face detection **Off** (default) or **On**.
- **ISO** - Set how sensitive the camera is to light. Options: **Auto** (default), **ISO Auto (HJR)**, **ISO100**, **ISO200**, **ISO400**, **ISO800** or **ISO1600**.
- **Exposure** - Touch to adjust the exposure settings. Options: **+2**, **+1**, **0** (default), **-1** or **-2**.
- **White balance** - Select how the camera adjusts colors in different kinds of light, to achieve the most natural-looking colors:
  -  **Incandescent** - Adjust the white balance for incandescent lighting.
  -  **Fluorescent** - Adjust the white balance for florescent lighting.
  -  **Auto** - Adjust the white balance automatically (default).
  -  **Daylight** - Adjust the white balance for daylight.
  -  **Cloudy** - Adjust the white balance for a cloudy environment.
- **Redeye reduction** - Helps eliminate redeye effect. Options: **Disabled** (default), or **Enable**.
- **ZSL** - Set the camera to immediately take a picture when the button is pressed (default – enabled)
- **Selfie Mirror** - Options: **Disable** (default), or **Enable**.
- **Shutter Sound** - Select to play a shutter sound when taking a photo. Options: **Disable** (default) or **Enable**.
- **Anti Banding** - Allows the camera to avoid problems caused by artificial light sources that are not constant. These sources cycle (flicker) fast enough to go unnoticed to the human eye, appearing continuous. The camera's eye (its sensor) can still see this flicker. Options: **Auto** (default), **60 Hz**, **50 Hz**, or **Off**.

### Rear Camera






- **Flash** - Select whether the camera relies on its light meter to decide whether a flash is necessary, or to turn it on or off for all shots.
  -  **Off** - Disable flash.
  -  **Auto** - Adjust flash automatically depending upon light meter (default).
  -  **On** - Enable flash upon taking a photo.
- **GPS location** - Turn On or Off (default). ET56 only.
- **Picture size** - The size (in pixels) of the photo to: **13M pixels** (default), **8M pixels**, **5M pixels**, **3M pixels**, **HD 1080**, **2M pixels**, **HD720**, **1M pixels**, **WVGA**, **VGA**, or **QVGA**.
- **Picture quality** - Set the picture quality setting to: **Low**, **Standard** (default) or **High**.
- **Countdown timer** - Select **Off** (default), **2 seconds**, **5 seconds** or **10 seconds**.
- **Storage** – Set the location to store the photo to: **Phone** or **SD Card**.
- **Face Detection** - Select to turn face detection **Off** (default) or **On**.
- **ISO** - Set camera sensitivity to light to: **Auto** (default), **ISO Auto (HJR)**, **ISO100**, **ISO200**, **ISO400**, **ISO800** or **ISO1600**.
- **Exposure** - Set the exposure settings to: **+2**, **+1**, **0**(default), **-1** or **-2**.

- **White balance** - Select how the camera adjusts colors in different kinds of light, to achieve the most natural-looking colors:
  -  **Incandescent** - Adjust the white balance for incandescent lighting.
  -  **Fluorescent** - Adjust the white balance for florescent lighting.
  -  **Auto** - Adjust the white balance automatically (default).
  -  **Daylight** - Adjust the white balance for daylight.
  -  **Cloudy** - Adjust the white balance for a cloudy environment.
- **Chroma Flash** - Sets the camera to take two pictures, one with flash and one without flash. The two images are combined to produce a final image with the sharpness and clarity and bright color tones from a picture with the flash, coupled with the natural colors of a picture without a flash. Options: **Off** (default) or **On**.
- **Redeye reduction** - Helps eliminate redeye effect. Options: **Disabled** (default), or **Enable**.
- **ZSL** - Set the camera to immediately take a picture when the button is pressed (default – enabled).
- **Shutter Sound** - Select to play a shutter sound when taking a photo. Options: **Disable** (default) or **Enable**.
- **Anti Banding** - Allows the camera to avoid problems caused by artificial light sources that are not constant. These sources cycle (flicker) fast enough to go unnoticed to the human eye, appearing continuous. The camera's eye (its sensor) can still see this flicker. Options: **Auto** (default), **60 Hz**, **50 Hz**, or **Off**.








## Video Settings

In Video mode, video settings appear on screen. Touch  to display the video settings options.

### Front Camera

- **Video quality** - Set video quality to: **HD1080** (default), **HD 720p**, **SD 480p**, **VGA**, **CIF**, or **QVGA**.
- **Video duration** - Set to: **30 seconds (MMS)** or **30 minutes** (default).
- **GPS location** - Turn **On** or **Off** (default). ET56 only.
- **Storage** – Set the location to store the photo to: **Phone** (default) or **SD Card**.
- **White balance** - Select how the camera adjusts colors in different kinds of light, to achieve the most natural-looking colors.
  -  **Incandescent** - Adjust the white balance for incandescent lighting.
  -  **Fluorescent** - Adjust the white balance for florescent lighting.
  -  **Auto** - Adjust the white balance automatically (default).
  -  **Daylight** - Adjust the white balance for daylight.
  -  **Cloudy** - Adjust the white balance for a cloudy environment.
- **Image Stabilization** - Set to reduce blurry videos due to device movement. Options: **On** or **Off** (default).

## Rear Camera


- **Flash** - Select whether Rear-facing Camera relies on its light meter to decide whether a flash is necessary, or to turn it on or off for all shots.
  -  **Off** - Disable flash (default).
  -  **On** - Enable flash.
- **Video quality** - Set video quality to: **4k DCI**, **4k UHD**, **HD 1080p** (default), **HD 720p**, **SD 480p**, **VGA**, **CIF**, or **QVGA**.
- **Video duration** - Set to: **30 seconds (MMS)**, or **30 minutes** (default).
- **GPS location** - Turn On or Off (default). ET56 only.
- **Storage** – Set the location to store the photo to: **Phone** (default) or **SD Card**.
- **White balance** - Select how the camera adjusts colors in different kinds of light, to achieve the most natural-looking colors.
  -  **Incandescent** - Adjust the white balance for incandescent lighting.
  -  **Fluorescent** - Adjust the white balance for florescent lighting.
  -  **Auto** - Adjust the white balance automatically (default).
  -  **Daylight** - Adjust the white balance for daylight.
  -  **Cloudy** - Adjust the white balance for a cloudy environment.
- **Image Stabilization** - Set to reduce blurry videos due to device movement. Options: **On** or **Off** (default).

## Contacts


Use the **Contacts** app to manage contacts.

From a Home or Apps screen, touch **Contacts** to open to the main list of contacts. Contacts are listed in alphabetical order. Swipe up or down to scroll through the list.


### Adding a Contact

1. In the **Contacts** app, touch .
2. If there is more than one account with contacts, touch the one you want to use.
3. Type the contact's name and other information. Touch a field to start typing, and swipe down to view all categories.
4. To open a menu with preset labels, such as Home or Work for an email address, touch the label to the right of the item of contact information. Or, to create your own label, touch **Custom** in the menu.
5. Touch the check mark next to **Add New Contact**.

### Editing Contacts

1. In the **Contacts** app, touch a contact name to edit.
2. Touch .
3. Edit the contact information.
4. Touch **SAVE**.

### Deleting Contacts

1. In the **Contacts** app, touch a contact name to delete.
2. Touch .
3. Touch **Delete**.
4. Touch **DELETE** to confirm.

## DataWedge Demonstration



**NOTE:** DataWedge is disabled on the Home screen. To enable this feature, go to the DataWedge settings and enable the **Launcher** profile.

Use **DataWedge Demonstration** to demonstrate data capture functionality.

Figure 36 DataWedge Demonstration Window

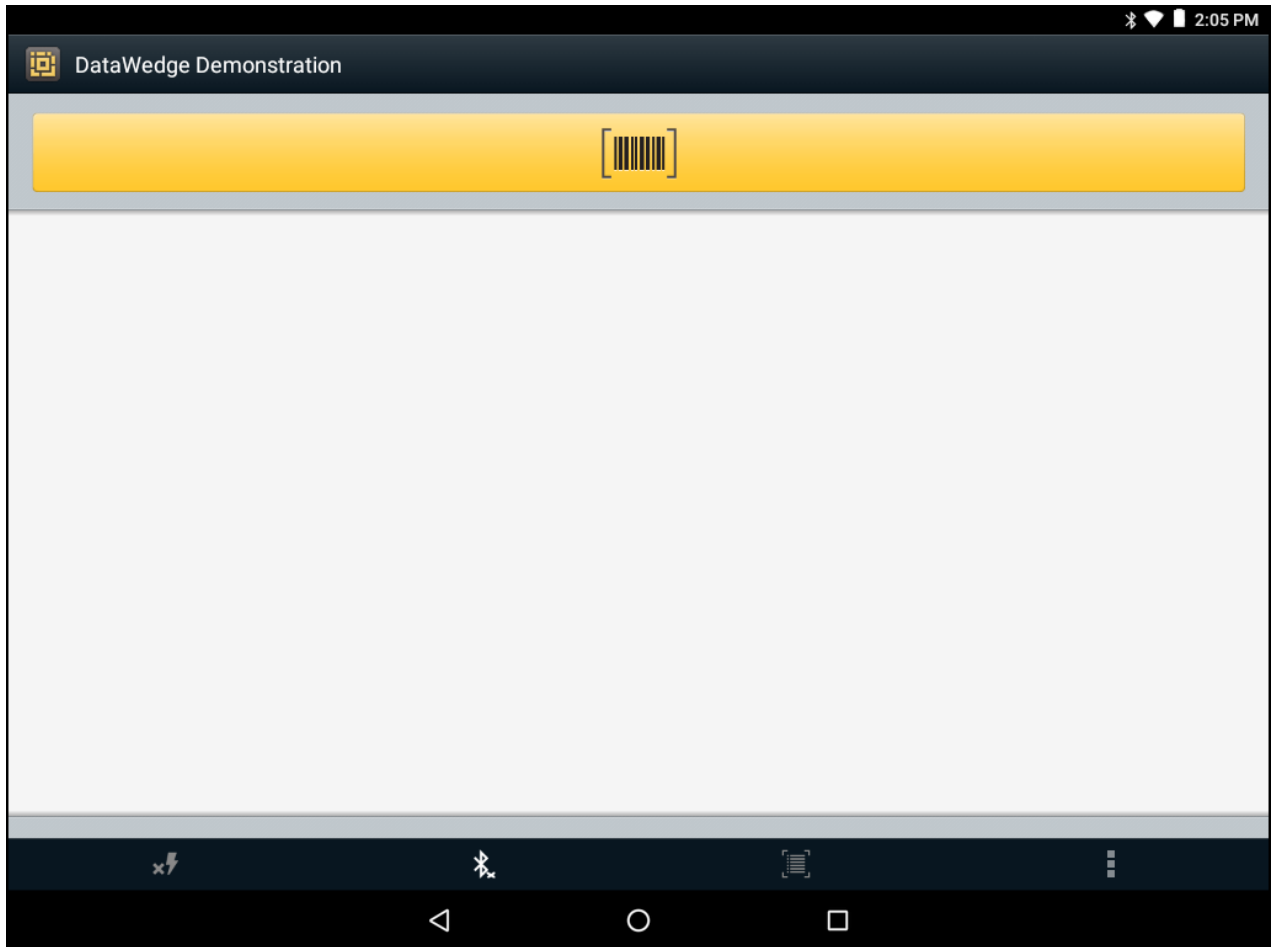











Table 11 DataWedge Demonstration Icons

	Icon	Description
Illumination		Imager illumination is on. Touch to turn illumination off.
		Imager illumination is off. Touch to turn illumination on.

Table 11 DataWedge Demonstration Icons (Continued)

	Icon	Description
Data Capture		Indicates data capture function is through the internal imager (ET51 with Integrated Scanner only).
		Indicates a USB scanner is connected to the device.
		Indicates a USB scanner is not connected to the device.
		Indicates a Bluetooth scanner is connected.
		Indicates a Bluetooth scanner is not connected.
		Indicates data capture function is through the rear camera.
Scan Mode		Indicates imager is in picklist mode. Touch to change to normal scan mode.
		Indicates imager is in normal scan mode. Touch to change to picklist mode.
		Opens a menu to view the application information or to set the application DataWedge profile.



**NOTE:** See the ET51/56 Tablet Integrator Guide for Android Version 8.1.0 for information on DataWedge configuration.

## Scanner Selection


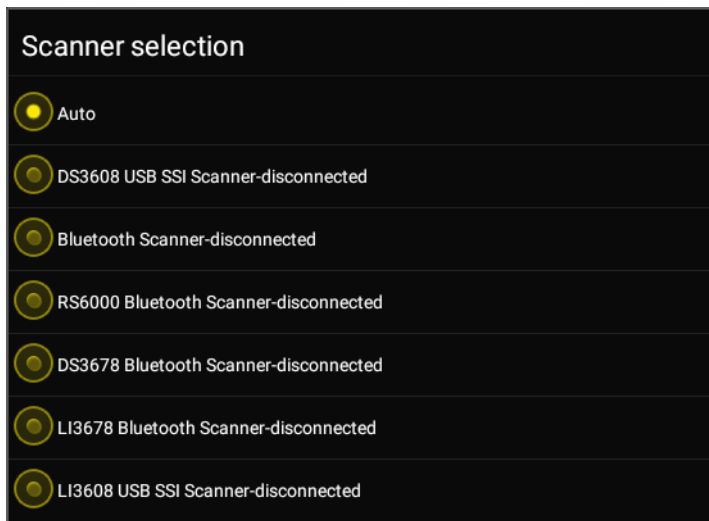
To select a scanner, touch  > **Settings** > **Scanner selection**.

Figure 37 Data Capture Options Menu





## Applications

Press the scanner trigger button or touch the on-screen yellow scan button to capture data. The data appears in the text field below the yellow button.

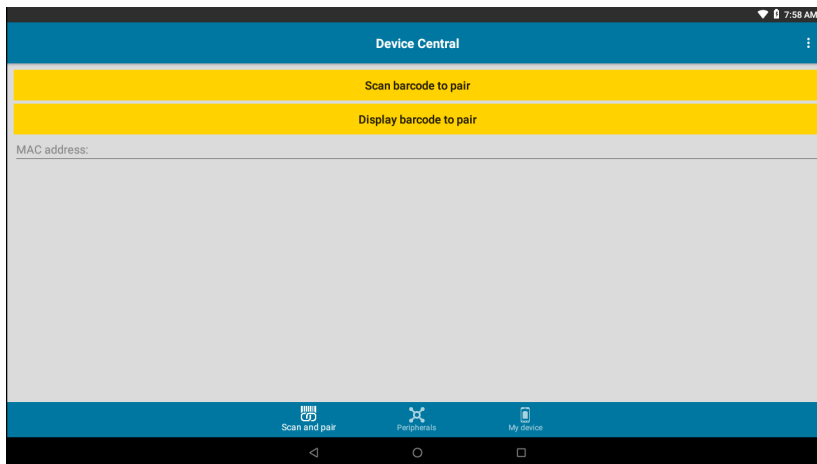
## Device Central

**Device Central** displays detailed information about the device and connected peripherals and supports the following Zebra devices:

**Device Central** features include:

- Discovering and pairing with supported peripherals via Bluetooth or corded connection.
- Paging a connected RS6000 Ring Scanner.
- Displaying the connection status of peripherals.
- Displaying information for a connected peripheral in the notification bar.

Figure 38 Device Central Screen



Touch **Get Info** to read the cradle information.

## Scan and Pair Tab

Pairing to a Bluetooth peripheral is accomplished by one of the following methods:

- Scan and Pair
- Scan to Pair
- Manually Pairing.

### Scan and Pair

To scan the peripheral Bluetooth barcode to pair:

1. In the **Scan and Pair** tab, touch **Scan barcode to pair**. The peripheral's scan beam illuminates.
2. Ensure that Bluetooth is enabled on the peripheral and is set to discoverable mode. Refer to the peripheral user guide for instructions.
3. Scan the Bluetooth MAC address barcode label on the desired peripheral to pair.

When pairing is successful, the peripheral displays in the list. A green dot appears next to a Bluetooth scanner when the device is connected, and may be in use. A red dot appears next to other Bluetooth peripherals, such as a Bluetooth headset or printer, while they are connected but not in use.

## Scan to Pair

Use Scan and Pair to pair by scanning a barcode displayed on the screen. This applies to peripherals that have scanning capability, such as Bluetooth handheld scanners and ring scanners.

1. In the **Scan and Pair** tab, touch **Display barcode to pair**. A barcode displays.
2. Using the peripheral, scan the barcode on the screen.

When the pairing is successful, the peripheral displays in the list with a green dot indicating that it is paired.

## Manually Pairing

To manually pair a peripheral that is unable to pair via Bluetooth:

1. In the **Scan and Pair** tab, touch the **MAC address** field.
2. Enter the Bluetooth MAC address of the peripheral.
3. Touch **Pair**.

When pairing is successful, the peripheral displays in the list. A green dot appears next to a Bluetooth scanner when the device is connected, and may be in use. A red dot appears next to other Bluetooth peripherals, such as a Bluetooth headset or printer, while they are connected but not in use.

## Peripherals Tab

The **Peripherals** Tab displays all currently connected and previously connected peripherals. Connected peripherals display the length of time (in minutes) that they have been connected.

Touch the connected device icon to display details about the peripheral. The **Device Details** screen appears. When an RS6000 is connected the **Page** button displays at the bottom of the **Device Details** screen. See Paging an RS6000 Ring Scanner.

## My Device Tab

The **My Device** Tab displays information about the device.

- **Device Model** - Displays the name assigned to the device.
- **Device Serial Number** - Displays the serial number of the device.
- **OS Version** - Displays the operating system version.
- **Build Number** - Displays the software build number.
- **Battery Level** - The current battery charge level as a percentage.
- **Battery Part Number** - The battery part number.
- **Battery Serial Number** - The battery serial number. The number matches the serial number printed on the battery label.
- **Battery Manufactured Date** - The date of manufacture.

## Unpairing a Peripheral

To unpair a Bluetooth peripheral:

1. In the **Scan and Pair** tab, touch **Unpair** for the desired peripheral to unpair.  
A confirmation pop-up message appears.

2. Touch **OK**.

Once unpaired, a message appears indicating the peripheral has been disconnected, and the peripheral is removed from the list.

## Paging an RS6000 Ring Scanner

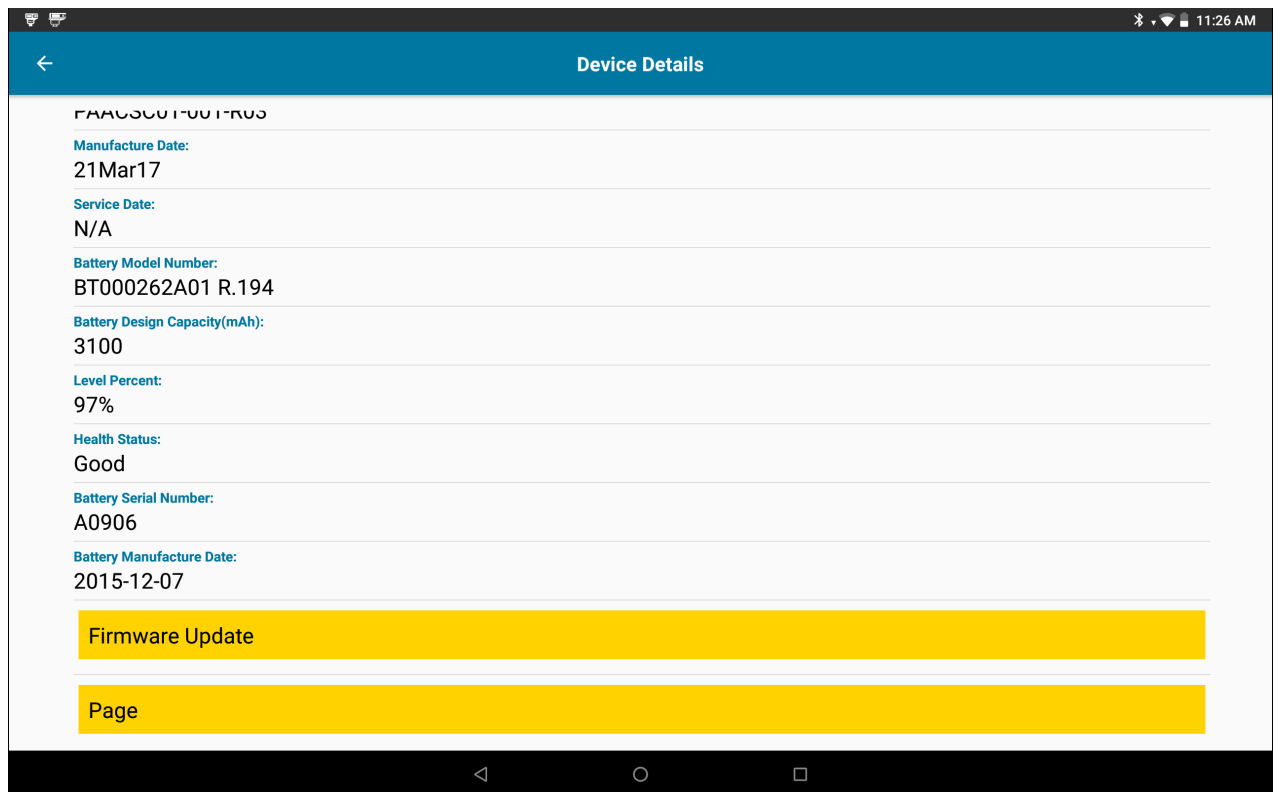
Use **Page** button to easily locate the currently connected RS6000 Ring Scanner:

1. With the RS6000 Ring Scanner connected, swipe up from the bottom of the Home screen, and touch .



**NOTE:** The RS6000 Ring Scanner must be within 10 m (32 ft) of the device.

2. Under the RS6000 peripheral information, touch **Page** to page the RS6000. The paged RS6000 beeps and vibrates.



To stop paging, press the scan trigger of the RS6000. On a triggerless RS6000, reset the RS6000 to stop paging. Refer to the RS6000 User Guide.

## Diagnostic Tool

The **Diagnostic Tool** is a utility that determines the health of the device. Use the Diagnostic Tool to troubleshoot the device.


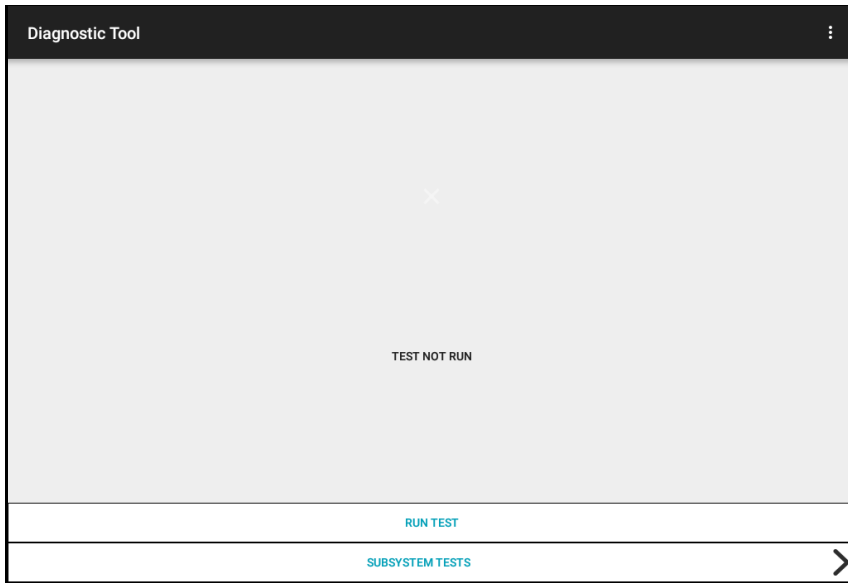
1. Swipe up from the bottom of the Home screen and touch .

Figure 39 Diagnostic Tool



2. Touch **RUN TEST**. The app tests all enabled subsystems (by default, only the Battery and System tests). See Settings to enable subsystem tests.

Figure 40 Test Passed Screen

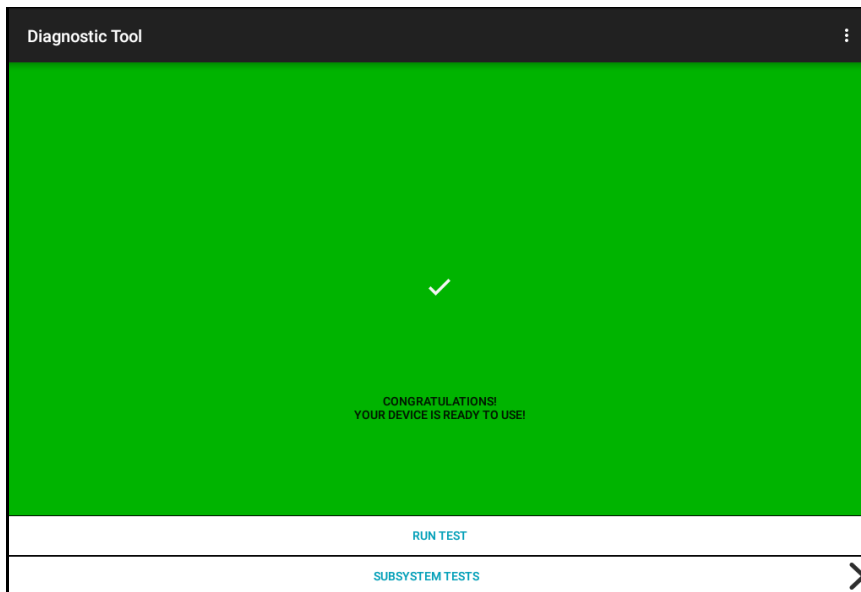
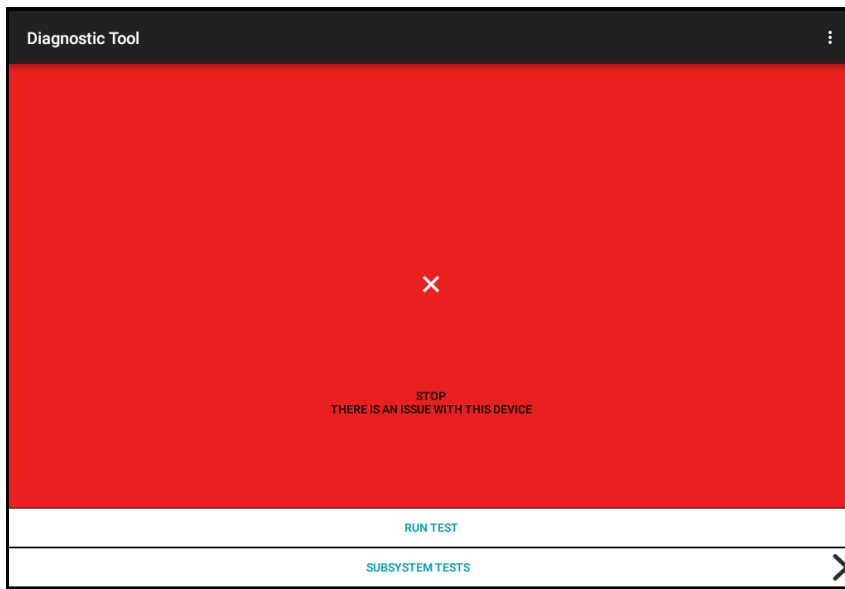
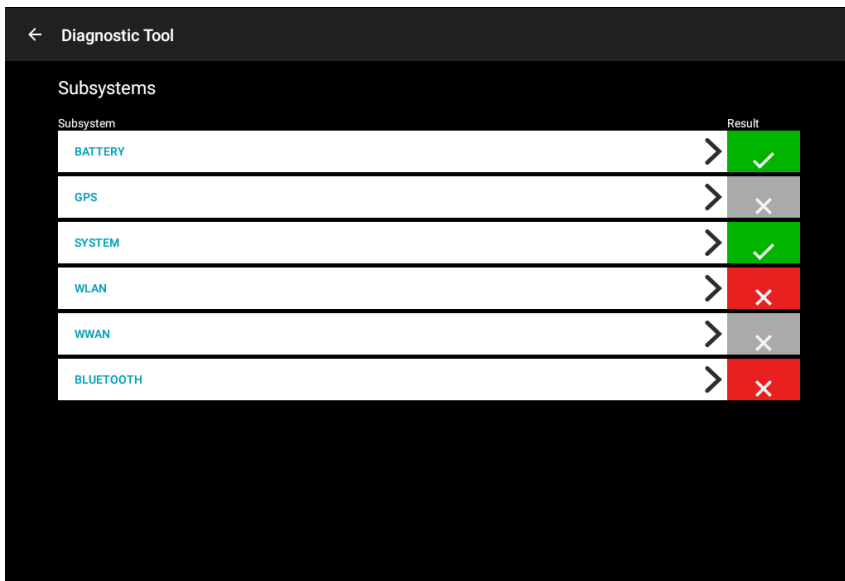


Figure 41 Test Failed Screen



3. To view each subsystem test, touch **Subsystem Tests**.

Figure 42 Subsystem Screen



4. Touch one of the subsystems to view details.

Table 12 Subsystem Test Result Indicators

Status Icon	Description
	Test passed.
	Test failed.
	Test not supported or not enabled.

Figure 43 Battery Subsystem Details

Battery Test:	
Statistics:	
Battery Level 96%	✓
Battery Voltage 12.281 V	i
Status Discharging	i
Power Source AC Power	i
Temperature 34.1° C	✓
Health Percentage 255%	✓
Backup Battery Voltage 0 V	i
Manufacture Date 2017-07-13	i

## Settings

By default only the Battery and System tests are enabled. To enable other tests:

1. Touch **☰** > **Settings**.
2. Touch to the left of the test name. A green box with a checkmark appears.
3. Touch **SAVE**.
4. Touch **Yes** to confirm.
5. Touch **◀**.

## Battery Test Information

The Battery Test obtains the following information:

- **Battery Level** - Current battery charge level
- **Battery Voltage** - Current battery voltage
- **Status** - Whether the battery is charging (on AC power) or discharging (on battery power)
- **Power Source** - Whether the device is receiving power from the battery or from an external source
- **Temperature** - Current battery temperature
- **Health Percentage** - Indicates the ratio of present capacity to design capacity at a discharge rate of design capacity.
- **Backup Battery Voltage** - Backup battery voltage.
- **Manufacture Date** - Manufacture date of the battery.

## System Test Information

Use the System Test to determine if the CPU or memory loads are too high, there are too many processes running on the device, or storage on the device is almost full.

The System Test obtains the following information:

- **CPU Load** - Amount of CPU being used
- **Free Physical Memory** - Amount of RAM available
- **Free Storage** - Amount of internal Flash memory available
- **Process Count** - Number of processes currently running.

## WLAN Test Information

If the Wi-Fi radio is not present or disabled, skip this test. This test determines if the device's WLAN configuration is correct or whether there is any connection with an access point or network.

The WLAN test obtains the following information:

- **WLAN Enabled** - WLAN radio is enabled or disabled
- **WLAN Status** - Current status of association with the access point
- **ESSID** - Name of the wireless network
- **BSSID** - MAC address of the connected access point
- **MAC Address** - Device's MAC address
- **Signal** - Strength of the Wi-Fi signal (in dBm)
- **IP Address** - IP address of the device.

## Bluetooth Test Information

The Bluetooth Test obtains the following information:

- **Enabled** - Whether the Bluetooth radio is enabled or disabled
- **Status** - Whether the device is paired to another Bluetooth device
- **Connectable/Discoverable** - Whether the device is discoverable or able to connect
- **Address** - Bluetooth radio MAC address
- **Name** - Bluetooth name for the device.



## Files

Use the **Files** app to view and manage files on the device.


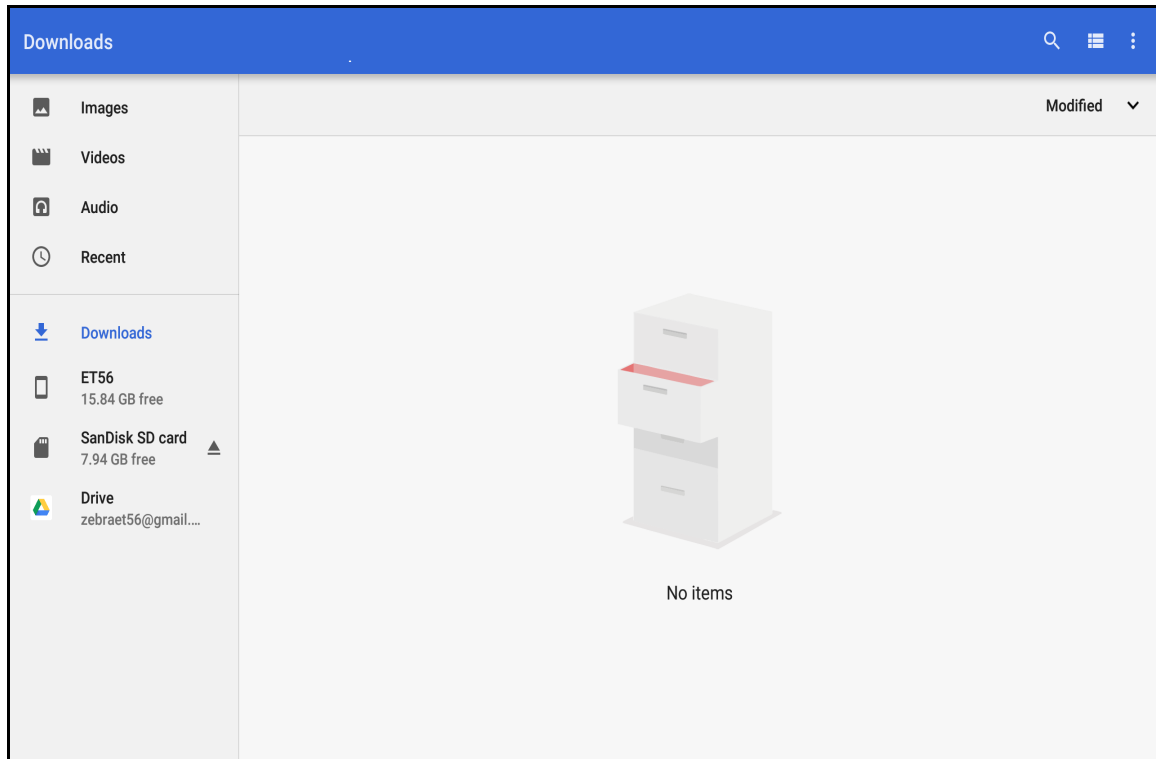








To open **Files**, swipe up from the bottom of the screen and touch .

Figure 44 Files Screen



- Touch and hold an item to open the File Operations menu. Select an option:
  -  - Share the file with other devices.
  -  - Delete the file.
  -  - View additional options.
    - **Open with** - Select which app is used to open the file.
    - **Select all** - Select all folders and files.
    - **Copy to...** - Copy the file.
    - **Move to...** - Move the file or folder to a new location.
    - **Compress** - Compress the selected file(s) into a ZIP file.
    - **Rename** - Rename the file.
- Touch the Sort drop-down to sort files by name, type, size, or date.
-  - View all file locations.
-  - Search for a specific file on the device.
-  /  - Change the folder to display items as a list / grid.

-  - Open the options menu.
- **New Window** - Create a new Files window.
- **New Folder** - Create a new folder.
- **Select all** - Select all folders and files.
- **Show/Hide internal storage** - Show or hide internal storage.

## Photos



**NOTE:** The device supports the following image formats: jpeg, gif, png, and bmp.

The device supports the following video formats: H.263, H.264, and MPEG4 Simple Profile.

Available on device with GMS only.

Use **Photos** to:

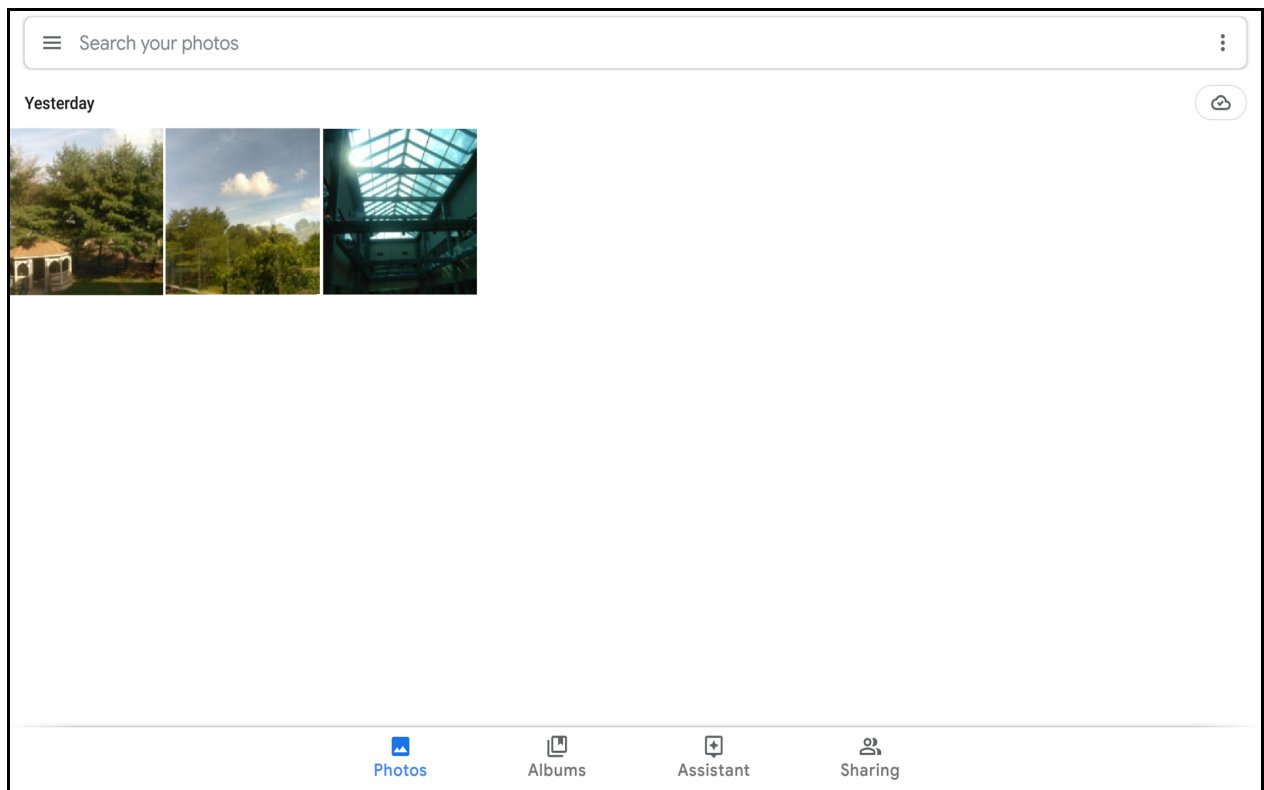
- View photos
- Play videos
- Perform basic editing of photos
- Set photos as wallpaper
- Set photos as a contact photo
- Share photos and videos.

**Photos** presents all photos and videos stored on the internal memory.

To open **Photos**, swipe up from the bottom of the Home screen and touch **Photos**.

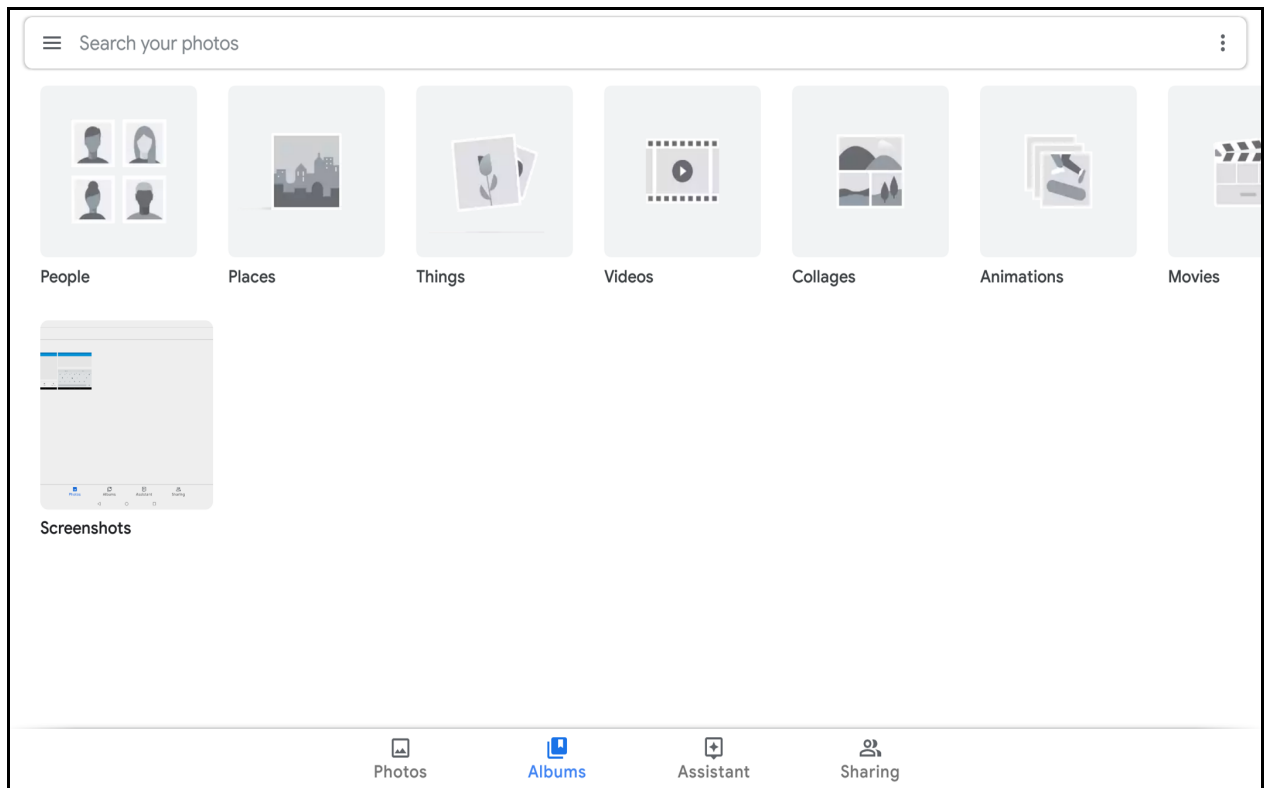
By default, **Photos** opens to the photos view.

Figure 45 Photos View



Touch **Albums** to view photos sorted by albums.

Figure 46 Albums View




- Touch an album to view its contents. The photos and videos in the album appear in chronological order.
- Touch a photo or video in an album to view it.
- Touch ← to return to the main screen.

## Working with Albums

Albums are groups of images and videos in folders. Touch an album to open it. The photos and videos are listed in a chronologically ordered grid. The name of the album displays at the top of the screen

Swipe up to scroll through the images.

## Sharing an Album

1. Swipe up from the bottom of the Home screen and touch **Photos**.
2. Touch **Albums**.
3. Touch an album.
4. Touch ⋮ > **Select**.
5. Select all photos in the album.
6. Touch . The Share menu opens.
7. Touch an app to share the selected albums.
8. Follow the instructions within the selected app.

## Deleting an Album

To delete an album and its contents:

1. Swipe up from the bottom of the Home screen and touch **Photos**.
2. Touch **Albums**.
3. Touch an album.
4. Touch **⋮** > **Select**.
5. Select all photos in the album.
6. Touch **🗑️**.
7. Touch **Move to trash** to delete the album.

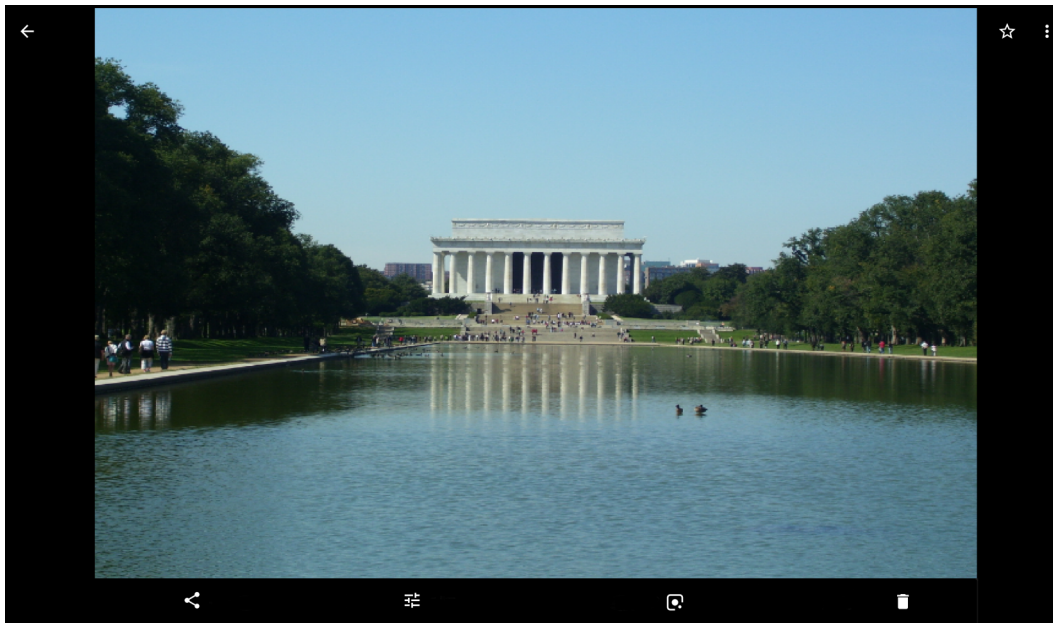
## Working with Photos

Use **Photos** to view photos on the internal memory.

### Viewing and Browsing Photos

1. Swipe up from the bottom of the Home screen and touch **Photos**.
2. Touch a photo.

Figure 47 Photo Example



3. Swipe left or right to view the next or previous photo in the album.
4. Turn the device to view the photo in upright (portrait) or sideways (landscape) orientation. The photo is displayed (but not saved) in the new orientation.
5. Touch the photo to view the controls.
6. Double-tap the screen to zoom in, or pinch two fingers together or spread them apart to zoom in or out.

7. Drag the photo to view parts that are not in view.

## Cropping a Photo




1. Swipe up from the bottom of the Home screen and touch **Photos**.
2. Touch a photo to view the controls.
3. Touch  > . The cropping tool appears.

Figure 48 Cropping Tool




4. Use the cropping tool to select the portion of the photo to crop.
  - Drag from the inside of the cropping area to move it.
  - Drag an edge of the cropping area to resize it to any proportion.
5. Touch **DONE**.
6. Touch **SAVE** to save a copy of the cropped photo. The original version is retained.

## Setting a Photo as a Contact Icon


1. Swipe up from the bottom of the Home screen and touch **Photos**.
2. Touch the photo to open it.
3. Touch  > **Use as**.
4. Touch **Contact photo**.
5. In the **Contacts** app, touch a contact.
6. Touch the white box and crop the photo accordingly.

7. Touch **Done**.

### Sharing a Photo

1. Swipe up from the bottom of the Home screen and touch **Photos**.
2. Touch an album to open it.
3. Touch a photo to open it.
4. Touch .
5. Touch the app to use to share the selected photo.
6. Follow the instructions within the selected app.

### Deleting a Photo

1. Swipe up from the bottom of the Home screen and touch **Photos**.
2. Touch a photo to open it.
3. Touch .
4. Touch **MOVE TO TRASH**.


## Working with Videos

Use **Photos** to view and share videos.


### Watching a Video

1. Swipe up from the bottom of the Home screen and touch **Photos**.
2. Touch a video to play.
3. Touch the screen to view the playback controls.

### Sharing a Video

1. Swipe up from the bottom of the Home screen and touch **Photos**.
2. Touch a video to open it.
3. Touch . The Share menu appears.
4. Touch the app to use to share the selected video.
5. Follow the instructions within the selected app.

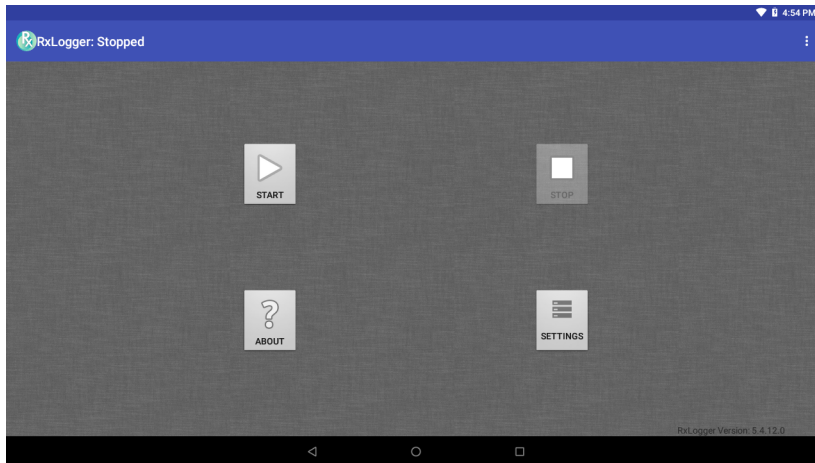
### Deleting a Video

1. Swipe up from the bottom of the Home screen and touch **Photos**.
2. Touch a video to open it.
3. Touch .
4. Touch **MOVE TO TRASH** to delete the video.

## RxLogger

RxLogger is a comprehensive diagnostic tool that provides app and system metrics. Create custom plug-ins that work seamlessly with this tool. RxLogger diagnoses device and application issues, and tracks information for: CPU load, memory load, memory snapshots, battery consumption, power states, wireless logging, TCP dumps, Bluetooth logging, GPS logging, logcat, ANR dumps, etc. All logs and files generated are saved in flash storage on the device (internal or external).

Figure 49 RxLogger



## RxLogger Configuration

RxLogger is built with an extensible plug-in architecture and comes packaged with a number of plug-ins already built-in. The included plug-ins are described below.

To open the configuration screen, from the RxLogger home screen touch **Settings**.

Figure 50 RxLogger Configuration Screen






## Configuration File

RxLogger configuration can be set using an XML file. The `config.xml` configuration file is located in the `RxLogger\config` folder. Copy the file from the device to a host computer using a USB connection. Edit the configuration file and then replace the XML file on the device. There is no need to stop and restart the RxLogger service since the file change is automatically detected.


## Enabling Logging

To enable logging:

1. Swipe the screen up and select .
2. Touch **Start**.
3. Touch .

## Disabling Logging

To disable logging:

1. Swipe the screen up and select .
2. Touch **Stop**.
3. Touch .

## Extracting Log Files

1. Connect the device to a host computer using an USB connection.
2. Using a file explorer, navigate to the `RxLogger` folder.
3. Copy the file from the device to the host computer.
4. Disconnect the device from the host computer.

## RxLogger Utility

RxLogger Utility is a data monitoring application for viewing logs in the device while RxLogger is running. Access the logs and RxLogger Utility features in the App View or the Overlay View.

# Wireless

This section provides information on the wireless features:

- Wireless Local Area Network (WLAN)
- Wireless Wide Area Network (WWAN)
- Bluetooth
- Near Field Communications (NFC).

## Wireless Local Area Networks

Wireless local area networks (WLANs) allow the device to communicate wirelessly inside a building. Before using the device on a WLAN, the facility must be set up with the required hardware to run the WLAN (sometimes known as infrastructure). The infrastructure and the device must both be properly configured to enable this communication.

Refer to the documentation provided with the infrastructure (access points (APs), access ports, switches, Radius servers, etc.) for instructions on how to set up the infrastructure.

Once the infrastructure is set up to enforce the chosen WLAN security scheme, use the **Wireless & networks** settings configure the device to match the security scheme.

The device supports the following WLAN security options:

- Open
- Wireless Equivalent Privacy (WEP)
- Wi-Fi Protected Access (WPA)/WPA2 Personal (PSK)
- Extensible Authentication Protocol (EAP).
  - Protected Extensible Authentication Protocol (PEAP) - with MSCHAPV2 and GTC authentication
  - Transport Layer Security (TLS)
  - TTLS - with Password Authentication Protocol (PAP), MSCHAP and MSCHAPv2 authentication.
  - PWD
  - LEAP.

The **Status** bar displays icons that indicate Wi-Fi network availability and Wi-Fi status.



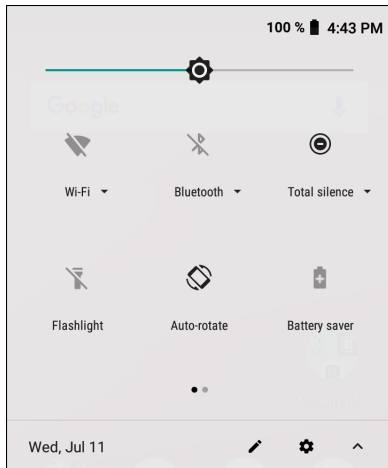
**NOTE:** To extend the life of the battery, turn off Wi-Fi when not in use.

## Connecting to a Wi-Fi Network

To connect to a Wi-Fi network:

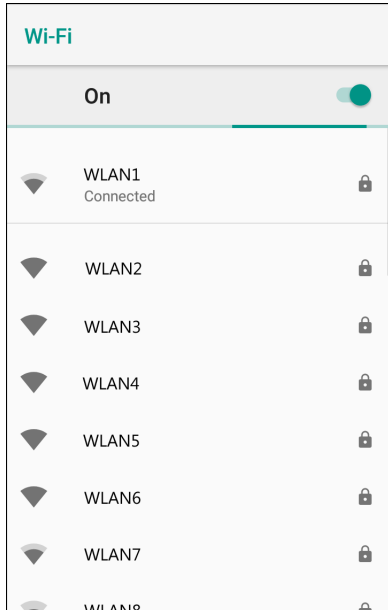
1. Swipe down from the Status bar to open the Quick Access panel.

Figure 51 Quick Access Panel



2. Touch **Wi-Fi** to open the **Wi-Fi** screen. The device searches for WLANs in the area and lists them.

Figure 52 Wi-Fi Screen



3. Scroll through the list and select the desired WLAN network.
4. For open networks, touch profile once or press and hold and then select **Connect to network** or for secure networks enter the required password or other credentials then touch **Connect**. See the system administrator for more information.

The device obtains a network address and other required information from the network using the dynamic host configuration protocol (DHCP) protocol. To configure the device with a fixed internet protocol (IP) address, Refer to the device Integrator Guide for more information.

5. In the Wi-Fi setting field, **Connected** appears indicating that the device is connected to the WLAN.

## Configuring a Secure Wi-Fi Network

To set up a Wi-Fi network:


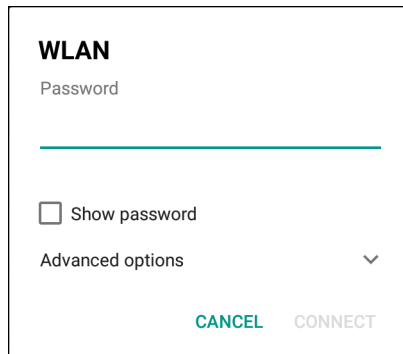
1. Swipe down from the Status bar to open the Quick Access panel and then touch .
2. Touch **Network & Internet > Wi-Fi**.
3. Slide the switch to the **ON** position.
4. The device searches for WLANs in the area and lists them on the screen.
5. Scroll through the list and select the desired WLAN network.
6. Touch the desired network. If the network security is **Open**, the device automatically connects to the network. For all other network security a dialog box appears.

Figure 53 WLAN WEP Network Security Dialog Box



The dialog box is titled "WLAN" and contains the following elements:

- A label "Password" above a text input field.
- A checkbox labeled "Show password" with an unchecked box.
- A label "Advanced options" followed by a downward-pointing chevron icon.
- Two buttons at the bottom: "CANCEL" in teal and "CONNECT" in grey.

Figure 54 WLAN 802.11 EAP Network Security Dialog Box

7. If the network security is **WEP** or **WPA/WPS2 PSK**, enter the required password and then touch **Connect**.
8. If the network security is 802.1x EAP:
  - Touch the **EAP method** drop-down list and select **PEAP, TLS, TTLS, PWD, or LEAP**.
  - Touch the **Phase 2 authentication** drop-down list and select an authentication method.
  - If required, touch **CA certificate** and select a Certification Authority (CA) certificate. Note: Certificates are installed using the **Security** settings.
  - If required, touch **User certificate** and select a user certificate. Note: User certificates are installed using the Location & security settings.
  - If required, in the **Identity** text box, enter the username credentials.
  - If desired, in the **Anonymous identity** text box, enter an anonymous identity username.
  - If required, in the **Password** text box, enter the password for then given identity.




**NOTE:** By default, the network Proxy is set to **None** and the IP settings is set to **DHCP**. See Configuring for a Proxy Server for setting connection to a proxy server and see Configuring the Device to Use a Static IP Address for setting the device to use a static IP address.

9. Touch **Connect**.

10. Touch .

## Manually Adding a Wi-Fi Network

Manually add a Wi-Fi network if the network does not broadcast its name (SSID) or to add a Wi-Fi network when out of range.

1. Swipe down from the Status bar to open the Quick Access panel and then touch .

2. Touch **Network & Internet > Wi-Fi**.
3. Slide the Wi-Fi switch to the **On** position.
4. Scroll to the bottom of the list and select **Add network**.
5. In the **Network name** text box, enter the name of the Wi-Fi network.
6. In the **Security** drop-down list, set the type of security to:
  - **None**
  - **WEP**
  - **WPA/WPA2 PSK**
  - **802.1x EAP**.
7. If the network security is **None**, touch **Save**.
8. If the network security is **WEP** or **WPA/WPA2 PSK**, enter the required password and then touch **Save**.
9. If the network security is **802.1x EAP**:
  - Touch the **EAP method** drop-down list and select **PEAP, TLS, TTLS, PWD, or LEAP**.
  - Touch the **Phase 2 authentication** drop-down list and select an authentication method.
  - If required, touch **CA certificate** and select a Certification Authority (CA) certificate. Note: Certificates are installed using the **Security** settings.
  - If required, touch **User certificate** and select a user certificate. Note: User certificates are installed using the **Security** settings.
  - If required, in the **Identity** text box, enter the username credentials.
  - If desired, in the **Anonymous** identity text box, enter an anonymous identity username.
  - If required, in the **Password** text box, enter the password for the given identity.



**NOTE:** By default, the network Proxy is set to **None** and the IP settings is set to **DHCP**. See Configuring for a Proxy Server for setting connection to a proxy server and see Configuring the Device to Use a Static IP Address for setting the device to use a static IP address.

10. Touch **Save**. To connect to the saved network, touch and hold on the saved network and select **Connect to network**.
11. Touch .

## Configuring for a Proxy Server

A proxy server is a server that acts as an intermediary for requests from clients seeking resources from other servers. A client connects to the proxy server and requests some service, such as a file, connection, web page, or other resource, available from a different server. The proxy server evaluates the request according to its filtering rules. For example, it may filter traffic by IP address or protocol. If the request is validated by the filter, the proxy provides the resource by connecting to the relevant server and requesting the service on behalf of the client.

It is important for enterprise customers to be able to set up secure computing environments within their companies, making proxy configuration essential. Proxy configuration acts as a security barrier ensuring that the proxy server monitors all traffic between the Internet and the intranet. This is normally an integral part of security enforcement in corporate firewalls within intranets.

To configure the device for a proxy server:


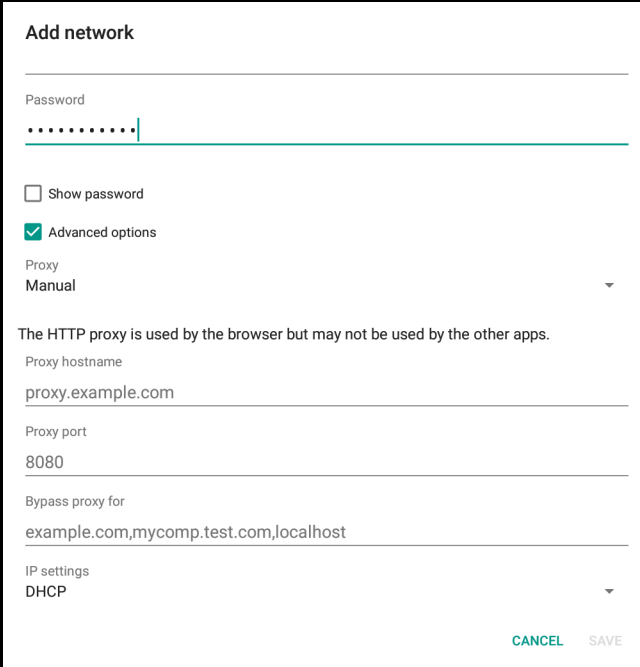
1. Swipe down from the Status bar to open the Quick Access panel and then touch .
2. Touch **Network & Internet > Wi-Fi**.
3. Slide the Wi-Fi switch to the **On** position.
4. In the network dialog box, select and touch a network.
5. Touch **Advanced options**.
6. Touch **Proxy** and select **Manual**.

Figure 55 Proxy Settings



**Add network**

Password  
 .....

Show password  
 **Advanced options**

Proxy  
**Manual**

The HTTP proxy is used by the browser but may not be used by the other apps.


Proxy hostname  
 proxy.example.com

Proxy port  
 8080

Bypass proxy for  
 example.com,mycomp.test.com,localhost

IP settings  
 DHCP


CANCEL SAVE

7. In the **Proxy hostname** text box, enter the address of the proxy server.
8. In the **Proxy port** text box, enter the port number for the proxy server.
9. In the **Bypass proxy for** text box, enter addresses for web sites that are not required to go through the proxy server. Use a comma “,” between addresses. Do not use spaces or carriage returns between addresses.
10. Touch **Connect**.
11. Touch .

## Configuring the Device to Use a Static IP Address

By default, the device is configured to use Dynamic Host Configuration Protocol (DHCP) to assign an Internet protocol (IP) address when connecting to a wireless network.

To configure the device to connect to a network using a static IP address:

1. Swipe down from the Status bar to open the Quick Access panel and then touch .
2. Touch **Network & Internet > Wi-Fi**.




3. Slide the Wi-Fi switch to the **On** position.
4. In the network dialog box, select and touch a network.
5. Touch **Advanced options**.
6. Touch **IP settings** and select **Static**.

Figure 56 Static IP Settings

The screenshot shows the 'Add network' dialog box with the following settings:

- Show password
- Advanced options
- Proxy: None
- IP settings: Static
- IP address: 192.168.1.128
- Gateway: 192.168.1.1
- Network prefix length: 24
- DNS 1: 8.8.8.8
- DNS 2: 8.8.4.4

At the bottom right, there are 'CANCEL' and 'SAVE' buttons.

7. In the **IP address** text box, enter an IP address for the device.
8. If required, in the **Gateway** text box, enter a gateway address for the device.
9. If required, in the **Network prefix length** text box, enter the prefix length.
10. If required, in the **DNS 1** text box, enter a Domain Name System (DNS) address.
11. If required, in the **DNS 2** text box, enter a DNS address.
12. Touch **Connect**.
13. Touch .

## Advanced Wi-Fi Settings



**NOTE:** Advanced Wi-Fi settings are for the device, not for a specific wireless network.

Use the **Advanced** settings to configure additional Wi-Fi settings. To view the advanced settings, scroll to the bottom of the **Wi-Fi** screen and select **Wi-Fi preferences > Advanced**.

- **Install Certificates** – Touch to install certificates.
- **Wi-Fi Direct** - Displays a list of devices available for a direct Wi-Fi connection.
- **WPS Push Button** - Touch to connect to a network using Wi-Fi Protected Setup (WPS) push button method.

- **WPS Pin Entry** - Touch to connect to a network using Wi-Fi Protected Setup (WPS) pin entry method.

## Additional Wi-Fi Settings



**NOTE:** Additional Wi-Fi settings are for the device, not for a specific wireless network.

Use the **Additional Settings** to configure additional Wi-Fi settings. To view the additional Wi-Fi settings, scroll to the bottom of the **Wi-Fi** screen and touch **Wi-Fi Preferences > Advanced > Additional settings**.

- **Regulatory**
  - **Country Selection** - Displays the acquired country code if 802.11d is enabled, else it displays the currently selected country code.
  - **Region code** - Displays the current region code.
- **Band and Channel Selection**
  - **Wi-Fi frequency band** - Set the frequency band to: **Auto** (default), **5 GHz only** or **2.4 GHz only**.
  - **Available channels (2.4 GHz)** - Touch to display the **Available channels** menu. Select specific channels and touch **OK**.
  - **Available channels (5 GHz)** - Touch to display the **Available channels** menu. Select specific channels and touch **OK**.
- **Logging**
  - **Advanced Logging** – Touch to enable advanced logging or change the log directory.
  - **Wireless logs** - Use to capture Wi-Fi log files.
    - **Fusion Logger** - Touch to open the **Fusion Logger** application. This application maintains a history of high level WLAN events which helps to understand the status of connectivity.
    - **Fusion Status** - Touch to display live status of WLAN state. Also provides information about the device and connected profile.
- **About**
  - **Version** - Displays the current Fusion information.

Figure 57 Fusion Logger Screen

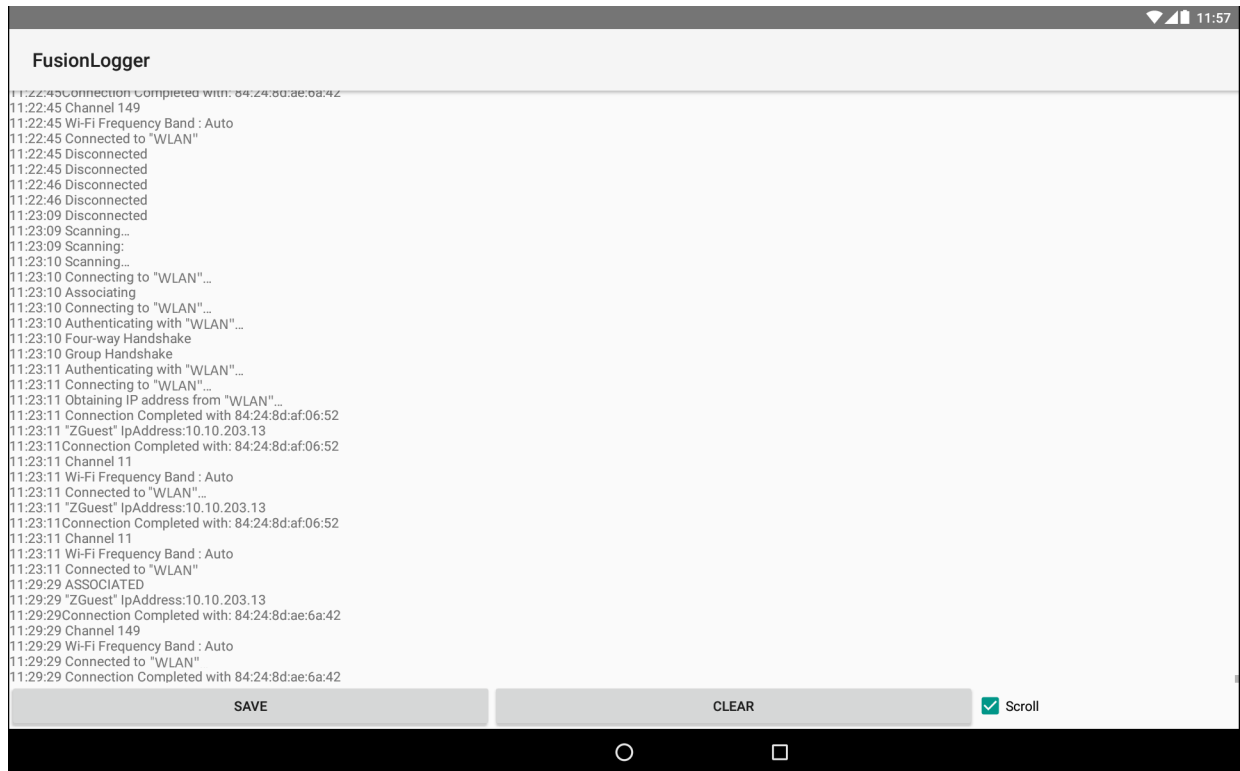
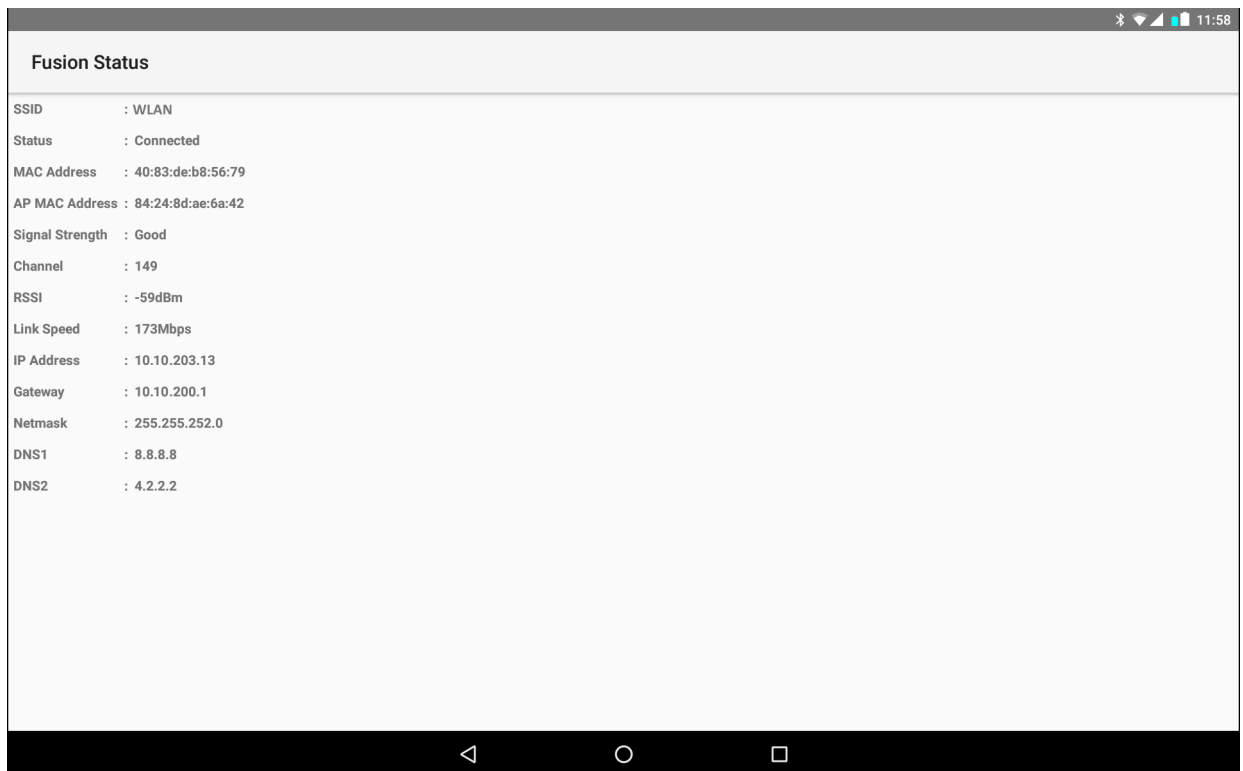


Figure 58 Fusion Status Screen



## Wi-Fi Advanced Features

Some additional Wi-Fi settings cannot be accessed from the User Interface. They can be configured by using Wi-Fi (CSP). Refer to EMDK documentation for the details on the Wi-Fi settings configuration using the Wi-Fi CSP.

- **Auto Time Config** - Using this feature, the device can sync up its time with legacy Zebra WLAN infrastructure. This feature works only when the device is connected to Zebra WLAN infrastructure and the feature is enabled on the WLAN infrastructure side. Default: disabled.
- **PMKID Caching** - Allows the device to skip 802.1x authentication during roaming if it had previously connected to that AP with a full 802.1x authentication. Default: disabled. Note: disable OKC when enabling PMKID Caching.
- **Opportunistic Key Caching** - Use this feature to skip 802.1x authentication during roaming. The device will go for full 802.1x authentication for the first time it connects to the network. For subsequent roaming, the device skips 802.1x authentication. Default: enabled.
- **Cisco Centralized Key Management** - Allows the device to skip 802.1x and key-handshake phases during roaming. This feature is available only when the device is connected to a Cisco infrastructure that supports Cisco Centralized Key Management (CCKM). Default: enabled.
- **Fast Transition** - Fast Transition (FT) is the fast roaming standard, 802.11r. With this feature, the device can skip 802.1x and key-handshake phases during roam. Default: enabled.
- **Fast Transition Resource Information Container** - Allows the device to request TSPEC as part of reassociation frame exchange. This helps to avoid sending a separate resource request after roaming is completed. Default: enabled.
- **Power Save** - The device can be configured to work in different power save modes:
  - i. **Active** - Keeps the WLAN radio always in active mode (i.e. power save mode disabled).
  - ii. **Power save using WMM-PS** - This is the default power save mode. Device uses WMM-PS power save method if the AP is configured to use this. If the AP is not supporting WMM-PS, the device will use PS-Poll power save method.
  - iii. **Power save using PS-Poll** - In this method, the device will use PS-Poll frames to retrieve buffered frames from the AP.
  - iv. **Null Data Power Save** - In Null Data Power Save (NDP), the device will stay awake for 100 ms after the last frame is sent or received. The device will send a Null Data packet with power management bit cleared to retrieve buffered frames from the AP.
- **802.11k** - Using 802.11k, the device can discover neighbor APs and adds support for different types of radio resource measurements. Default: enabled.
- **Band Preference** - The device can be configured to prefer one band over another. Default: disabled. **Subnet Roaming** - When the device roams between different sub networks, if it detects that it is roaming to a different subnet, the device will request a fresh IP address. Default: disabled.

## Resolving Wi-Fi and Bluetooth Wireless Interference Issues

Wireless interference can cause Wi-Fi and Bluetooth devices to disconnect or perform poorly. Interference can cause:

- Device does not connect or stay connected
- Connection is slow and signal strength is low
- Bluetooth audio skips, stutters, cuts off, or has static or buzzing
- Mouse movement is erratic or jumpy.

To reduce interference:

- Move the tablet and Wi-Fi router closer together.
- Move the Bluetooth devices closer together.
- Avoid using the tablet near power cables, microwave ovens, fluorescent lights, wireless video cameras, and cordless phones.
- Reduce the number of active devices that use the same wireless frequency band. If the Wi-Fi router supports 2.4 GHz and 5 GHz bands, connect more Wi-Fi devices to the 5 GHz band.
- Configure the Wi-Fi router to use a different Wi-Fi channel, or have it scan for the channel with the least interference.

When using USB-3 devices with the tablet, limit their potential to interfere with nearby wireless devices:

- Use a high-quality, shielded USB cable or accessory (for example, thumb drive. etc.).
- Move the tablet farther away from your wireless devices.
- Connect USB-3 devices to the ports farthest from your computer's Wi-Fi antenna. For example, if your computer has ports on the back, prefer the USB ports closest to the middle. If your computer has ports on the side, prefer the USB ports closest to the front.
- Turn off any USB 3 devices that are not in use.
- Switch to 5 GHz Wi-Fi, if available.

Avoid physical obstructions in the path of the wireless signal. For example, a metal surface between your Bluetooth mouse and tablet could cause the mouse to perform poorly, and a metal-reinforced concrete floor between your Wi-Fi router and Wi-Fi device could cause poor Wi-Fi performance.

- Low interference potential: wood, glass, and many synthetic materials
- Medium interference potential: water, bricks, marble
- High interference potential: plaster, concrete, bulletproof glass
- Very high interference potential: metal.

## Wireless Wide Area Networks



**NOTE:** ET56 only.

Use Wireless wide area networks (WWANs) to access data over a cellular network. This section provides information on:

- Sharing a data connection
- Monitoring data usage.
- Changing Cellular Network settings
- Locking a SIM card
- Configuring the Access Point (AP) name.


### Sharing the Mobile Data Connection

The **Tethering & Portable Hotspot** settings allows sharing the mobile data connection with a single computer via USB tethering or Bluetooth tethering. Share the data connection with up to eight devices at once, by turning it into a portable Wi-Fi hotspot. While the device is sharing its data connection, an icon displays at the top of the screen and a corresponding message appears in the notification list.

### Enabling USB Tethering



**NOTE:** USB tethering is not supported on computers running Mac OS. If the computer is running Windows or a recent version of Linux (such as Ubuntu), follow these instructions without any special preparation. If running a version of Windows that precedes Windows 7, or some other operating system, you may need to prepare the computer to establish a network connection via USB.

1. Connect the device to a host computer with the USB-C cable.
2. The notification **USB charging this device** appears in the Notifications panel.
3. Swipe down from the Status bar to open the Quick Access panel and then touch .
4. Touch **Network & Internet**.
5. Touch **Hotspot & tethering**.
6. Touch the **USB tethering** switch to enable.


The host computer is now sharing the device's data connection.

To stop sharing the data connection, touch the **USB tethering** switch again or disconnect the USB cable.

### Enabling Bluetooth Tethering

Use Bluetooth tethering to share the data connection with a host computer.

Configure the host computer to obtain its network connection using Bluetooth. For more information, see the host computer's documentation.



1. Pair the device with the host computer.
2. Swipe down from the Status bar to open the Quick Access panel and then touch .
3. Touch **Networking & Internet**.

4. Touch **Hotspot & tethering**.
5. Touch the **Bluetooth tethering** switch to enable.  
The host computer is now sharing the device's data connection.

To stop sharing the data connection, touch the **Bluetooth tethering** switch again.

## Enabling Wi-Fi Hotspot

To enable the Wi-Fi Hotspot:

1. Swipe down from the Status bar to open the Quick Access panel and then touch .
2. Touch **Network & Internet**.
3. Touch **Hotspot & tethering**.
4. Touch the **Wi-Fi hotspot** switch to enable.  
After a moment, the device starts broadcasting its Wi-Fi network name (SSID). Connect to it with up to eight computers or other devices. The Hotspot  icon appears in the Status bar.

To stop sharing the data connection, touch the **Portable Wi-Fi hotspot** switch again.

## Configuring the Wi-Fi Hotspot


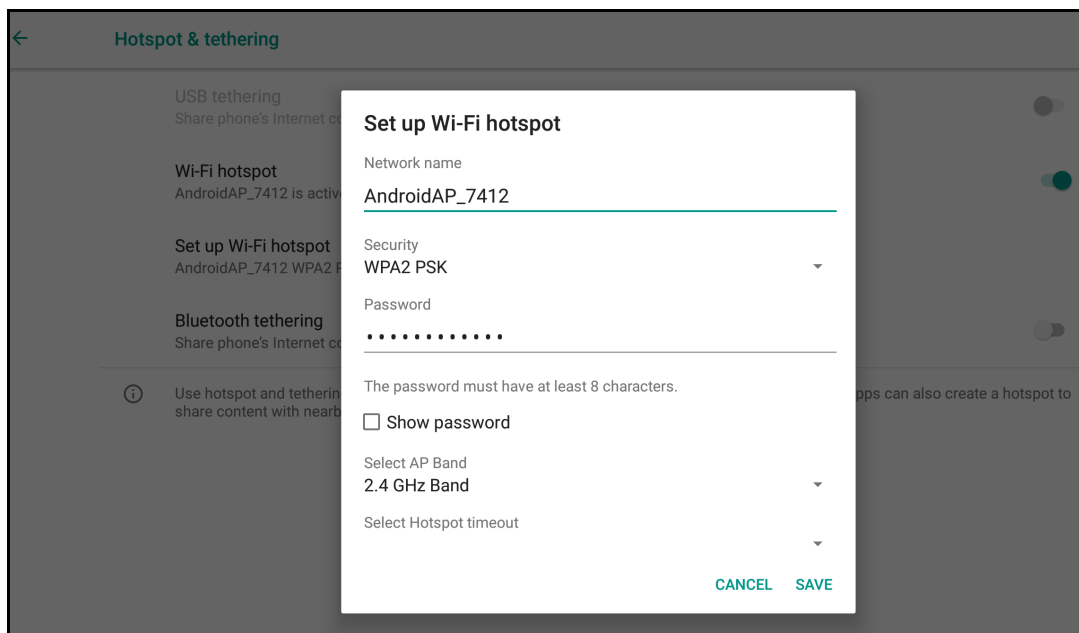
1. Swipe down from the Status bar to open the Quick Access panel and then touch .
2. Touch **Network & Internet**.
3. Touch **Hotspot & tethering**.
4. Touch **Set up Wi-Fi hotspot**.

Figure 59 Set up Wi-Fi Hotspot Dialog Box



5. In the **Network name** text field, edit the name for the hotspot.

6. Touch the **Security** option and select a security method from the drop-down list.
  - **None**
  - **WPA2 PSK.**




**NOTE:** If **None** is selected in the **Security** option, a password is not required.

7. In the **Password** text field, enter a password, if required.
8. In the **Select AP Band** drop-down list, select **2.4 GHz Band** or **5 GHz Band**.
9. Touch **Save**.

## Data Usage

Data usage refers to the amount of data uploaded or downloaded by the device during a given period. Depending on the wireless plan, you may be charged additional fees when your data usage exceeds your plan's limit.

To monitor your data usage:

1. Swipe down from the Status bar to open the Quick Access panel and then touch .
2. Touch **Network & internet > Data usage**.



**CAUTION:** The usage displayed on the data usage settings screen is measured by your device. Your carrier's data usage accounting may differ. Usage in excess of your carrier plan's data limits can result in steep overage charges. The feature described here can help you track your usage, but is not guaranteed to prevent additional charges.

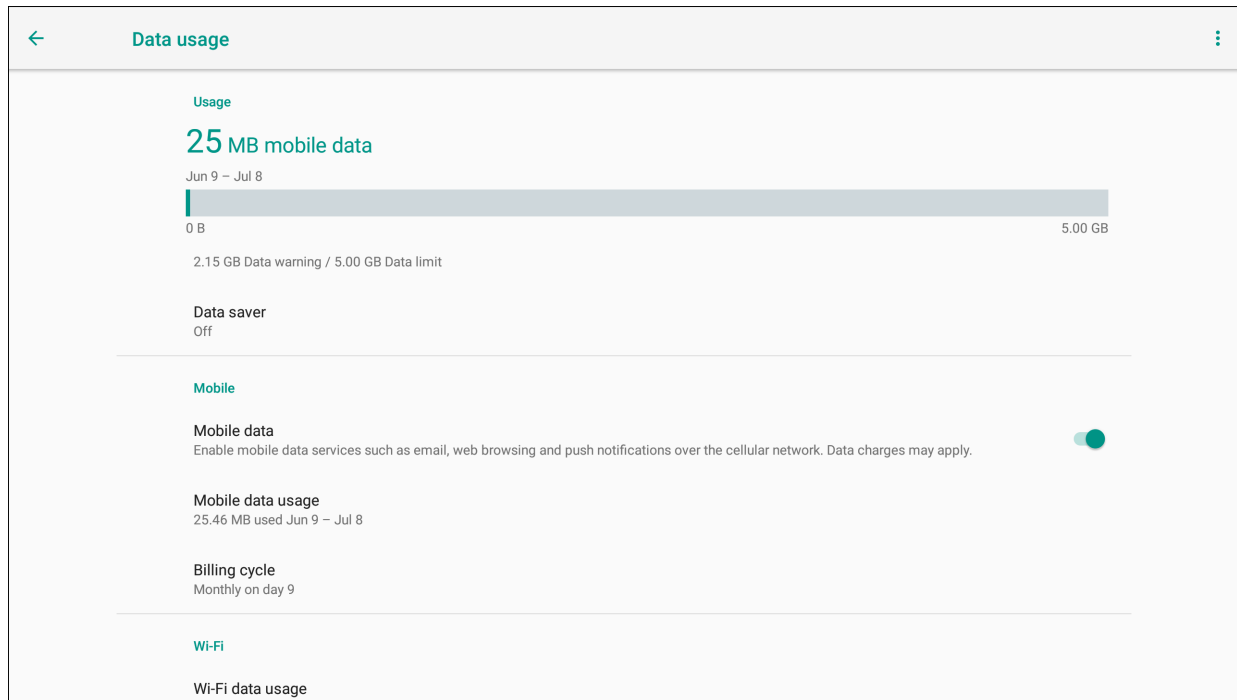
Data usage settings allow:

- Set the data usage warning level.
- Set a data usage limit.
- View or restrict data usage by app.
- Identify mobile hotspots and restrict background downloads that may result in extra charges.

By default, the data usage settings screen displays the mobile data settings. That is, the data network or networks provided by your carrier.





Figure 60 Data Usage Screen



## Setting Data Usage Warning


To set a warning alert when the device has used a certain amount of mobile data:

1. Swipe down from the Status bar to open the Quick Access panel and then touch .
2. Touch **Data usage**.
3. Touch **Mobile data usage** >  > **Set data warning**.
4. Touch **Data warning**.
5. Enter a number. To switch between megabytes (MB) and gigabytes (GB), touch the down arrow.
6. Touch **SET**.

When the usage reaches the set level, a notification appears.


## Disabling Data When Roaming

To prevent the device from transmitting data over other carriers' mobile networks when leaving an area that is covered by the carrier's networks. This is useful for controlling expenses if the service plan does not include data roaming.

1. Swipe down from the Status bar to open the Quick Access panel and then touch .
2. Touch **Network & Internet** > **Mobile network** > **Roaming**.

## Locking the SIM Card

Locking the SIM card requires the user to enter a PIN every time the device is turned on.

1. Swipe down from the Status bar to open the Quick Access panel and then touch .





2. Touch **Security & location**.
3. Touch **SIM card lock**.
4. Touch **Lock SIM card**.
5. Enter the PIN associated with the card. Touch **OK**.
6. Reset the device.

## Configuring the Access Point Name



**NOTE:** Many service provider Access Point Name (APN) data are pre-configured in the device. The APN information for all other service providers must be obtained from the wireless service provider.

To use the data on a network, configure the APN information:

1. Swipe down with two fingers from the status bar to open the quick access panel and then touch .
2. Touch **Network & Internet > Mobile network > Advanced**.
3. Touch **Access Point Names**.
4. Touch an APN name in the list to edit an existing APN or touch  to create a new APN.
5. Touch each APN setting and enter the appropriate data obtained from the wireless service provider.
6. When finished, touch  > **Save**.
7. Touch the radio button next to the APN name to start using it.
8. Touch .

## Bluetooth

Bluetooth devices can communicate without wires, using frequency-hopping spread spectrum (FHSS) radio frequency (RF) to transmit and receive data in the 2.4 GHz Industry Scientific and Medical (ISM) band (802.15.1). Bluetooth wireless technology is specifically designed for short-range (10 m (32.8 ft)) communication and low power consumption.

Devices with Bluetooth capabilities can exchange information (for example, files, appointments, and tasks) with other Bluetooth enabled devices such as printers, access points, and other mobile devices.

The device supports Bluetooth Low Energy. Bluetooth Low Energy is targeted at applications in the healthcare, fitness, security, and home entertainment industries. It provides reduced power consumption and cost while maintaining standard Bluetooth range.

## Adaptive Frequency Hopping

Adaptive Frequency Hopping (AFH) is a method of avoiding fixed frequency interferers, and can be used with Bluetooth voice. All devices in the piconet (Bluetooth network) must be AFH-capable in order for AFH to work. There is no AFH when connecting and discovering devices. Avoid making Bluetooth connections and discoveries during critical 802.11b communications. AFH for Bluetooth consists of four main sections:

- Channel Classification - A method of detecting an interference on a channel-by-channel basis, or pre-defined channel mask.
- Link Management - Coordinates and distributes the AFH information to the rest of the Bluetooth network.
- Hop Sequence Modification - Avoids interference by selectively reducing the number of hopping channels.
- Channel Maintenance - A method for periodically re-evaluating the channels.

When AFH is enabled, the Bluetooth radio “hops around” (instead of through) the 802.11b high-rate channels. AFH coexistence allows enterprise devices to operate in any infrastructure.

The Bluetooth radio in this device operates as a Class 2 device power class. The maximum output power is 2.5 mW and the expected range is 10 m (32.8 ft). A definition of ranges based on power class is difficult to obtain due to power and device differences, and whether in open space or closed office space.



**NOTE:** It is not recommended to perform Bluetooth wireless technology inquiry when high rate 802.11b operation is required.

## Security

The current Bluetooth specification defines security at the link level. Application-level security is not specified. This allows application developers to define security mechanisms tailored to their specific need. Link-level security occurs between devices, not users, while application-level security can be implemented on a per-user basis. The Bluetooth specification defines security algorithms and procedures required to authenticate devices, and if needed, encrypt the data flowing on the link between the devices. Device authentication is a mandatory feature of Bluetooth while link encryption is optional.

Pairing of Bluetooth devices is accomplished by creating an initialization key used to authenticate the devices and create a link key for them. Entering a common personal identification number (PIN) in the devices being paired generates the initialization key. The PIN is never sent over the air. By default, the Bluetooth stack responds with no key when a key is requested (it is up to user to respond to the key request event). Authentication of Bluetooth devices is based-upon a challenge-response transaction. Bluetooth allows for a PIN or passkey used to create other 128-bit keys used for security and encryption. The encryption key is

derived from the link key used to authenticate the pairing devices. Also worthy of note is the limited range and fast frequency hopping of the Bluetooth radios that makes long-distance eavesdropping difficult.

Recommendations are:

- Perform pairing in a secure environment
- Keep PIN codes private and do not store the PIN codes in the device
- Implement application-level security.

## Bluetooth Profiles

The device supports the Bluetooth services listed in the table below:

*Table 13 Bluetooth Profiles*

Profile	Description
Service Discovery Protocol (SDP)	Handles the search for known and specific services as well as general services.
Serial Port Profile (SPP)	Allows use of RFCOMM protocol to emulate serial cable connection between two Bluetooth peer devices. For example, connecting the device to a printer.
Object Push Profile (OPP)	Allows the device to push and pull objects to and from a push server.
Advanced Audio Distribution Profile (A2DP)	Allows the device to stream stereo-quality audio to a wireless headset or wireless stereo speakers.
Audio/Video Remote Control Profile (AVRCP)	Allows the device to control A/V equipment to which a user has access. It may be used in concert with A2DP.
Personal Area Network (PAN)	Allows the use of Bluetooth Network Encapsulation Protocol to provide L3 networking capabilities over a Bluetooth link. Only PANU role is supported.
Human Interface Device Profile (HID)	Allows Bluetooth keyboards, pointing devices, gaming devices and remote monitoring devices to connect to the device.
Headset Profile (HSP)	Allows a hands-free device, such as a Bluetooth headset, to place and receive calls on the device.
Hands-Free Profile (HFP)	Allows car hands-free kits to communicate with the device in the car.
Phone Book Access Profile (PBAP)	Allows exchange of Phone Book Objects between a car kit and a mobile device to allow the car kit to display the name of the incoming caller; allow the car kit to download the phone book so you can initiate a call from the car display.
Out of Band (OOB)	Allows exchange of information used in the pairing process. Pairing is completed using the Bluetooth radio, but requires information from the OOB mechanism. Using OOB with NFC enables pairing when devices simply get close, rather than requiring a lengthy discovery process.
File Transfer Profile (FTP)	Provides the capability to browse, manipulate and transfer files in file system of another system. Uses GOEP as a basis.
Generic Attribute Profile (GATT)	Provides profile discovery and description services for Bluetooth Low Energy protocol. It defines how attributes are grouped together into sets to form services.

Table 13 Bluetooth Profiles (Continued)

Profile	Description
HID Over GATT Profile (HOGP)	Defines the procedures and features used by Bluetooth low energy HID Devices using GATT and Bluetooth HID Hosts using GATT.
Scan Parameters Profile (ScPP)	Provides devices with information to assist them in managing their connection idle timeout and advertising parameters to optimize for power consumption and/or reconnection latency.
SIM Access Profile (SAP)	Allows devices such as car phones with built-in GSM transceivers to connect to a SIM card in a Bluetooth enabled device.
Message Access Profile (MAP)	Defines the features and procedures used by devices that exchange message objects.
Dial Up Networking (DUN)	Provides a standard to access the Internet and other dial-up services over Bluetooth.
Generic Access Profile (GAP)	Use for device discovery and authentication.
OBject EXchange (OBEX)	Facilitates the exchange of binary objects between devices.
Generic Object Exchange Profile (GOEP)	Provides a basis for other data profiles. Based on OBEX.
Generic Audio/Video Distribution Profile (GAVDP)	Provides the basis for A2DP and VDP, the basis of the systems designed for distributing video and audio streams using Bluetooth technology.

## Bluetooth Power States

The Bluetooth radio is off by default:

- Suspend - When the device goes into suspend mode, the Bluetooth radio stays on.
- Airplane Mode - When the device is placed in Airplane Mode, the Bluetooth radio turns off. When Airplane mode is disabled, the Bluetooth radio returns to the prior state. When in Airplane Mode, the Bluetooth radio can be turned back on if desired.

## Bluetooth Radio Power



Turn off the Bluetooth radio to save power or if entering an area with radio restrictions (for example, an airplane). When the radio is off, other Bluetooth devices cannot see or connect to the device. Turn on the Bluetooth radio to exchange information with other Bluetooth devices (within range). Communicate only with Bluetooth radios in close proximity.



**NOTE:** To achieve the best battery life, turn off radios when not in use.



### Enabling Bluetooth

To enable Bluetooth:

1. Swipe down from the Status bar to open the Quick Access panel.
2. Touch  to turn Bluetooth on.
3. Touch .

## Disabling Bluetooth

To disable Bluetooth:

1. Swipe down from the Status bar to open the Quick Access panel.
2. Touch  to turn Bluetooth off.
3. Touch .



## Discovering Bluetooth Device(s)

The device can receive information from discovered devices without pairing. However, once paired, the device and a paired device exchange information automatically when the Bluetooth radio is on. To find Bluetooth devices in the area:

1. Ensure that Bluetooth is enabled on both devices.
2. Ensure that the Bluetooth device to discover is in discoverable mode.
3. Ensure that the two devices are within 10 meters (32.8 feet) of one another.
4. Swipe down from the Status bar to open the Quick Access panel.
5. Touch **Bluetooth**.
6. Touch **MORE SETTINGS**. The **Bluetooth** screen appears.
7. Touch **Pair new device**. The device begins searching for discoverable Bluetooth devices in the area and displays them under **Available devices**.
8. Scroll through the list and select a device. The Bluetooth pairing request dialog box appears.
9. Touch **Pair** on both devices.
10. The Bluetooth device is added to the **Paired devices** list and a trusted (“paired”) connection is established.


## Changing the Bluetooth Name

By default, the device has a generic Bluetooth name that is visible to other devices when connected.

1. Swipe down from the Status bar to open the Quick Access panel and then touch .
2. Touch **Connected devices > Bluetooth**.
3. If Bluetooth is not on, move the switch to turn Bluetooth on.
4. Touch **Device name**.
5. Enter a name and touch **RENAME**.
6. Touch .

## Connecting to a Bluetooth Device



Once paired, connect to a Bluetooth device.

1. Swipe down from the Status bar to open the Quick Access panel and then touch .

2. Touch **Connected device > Bluetooth**.
3. In the list, touch the unconnected Bluetooth device.  
When connected, **Connected** appears below the device name.



## Selecting Profiles on the Bluetooth Device

Some Bluetooth devices have multiple profiles. To select a profile:

1. Swipe down from the Status bar to open the Quick Access panel and then touch .
2. Touch **Connected Devices > Bluetooth**.
3. In the **Paired Devices** list, touch  next to the device name.
4. Turn on or off a profile to allow the device to use that profile.
5. Touch .

## Unpairing a Bluetooth Device

To unpair a Bluetooth device and erase all pairing information:

1. Swipe down from the Status bar to open the Quick Access panel and then touch .
2. Touch **Connected devices > Bluetooth**.
3. In the **Paired Devices** list, touch  next to the device name.
4. Touch **FORGET**.
5. Touch .

## Near Field Communications

NFC/HF RFID is a short-range wireless connectivity technology standard that enables secure transaction between a reader and a contactless smartcard or other NFC devices. The technology is based on ISO/IEC 14443 type A and B (proximity) and ISO/IEC 15693 (vicinity) standards, using the HF 13.56 MHz unlicensed band. The device supports the following operating modes:

- Reader mode
- Peer-to-Peer communication
- Card Emulation mode.

Using NFC, the device can:

- Read contactless cards such as contactless tickets, ID cards and ePassport.
- Read and write information to contactless cards such as SmartPosters and tickets, as well as devices with NFC interface such as vending machines.
- Read information from supported medical sensors.
- Pair with supported Bluetooth devices such as printers , ring scanners (ex. RS6000), and headsets (ex. HS3100).
- Exchange data with another NFC device.
- Emulate contactless card such as payment, ticket, or Loyalty cards.

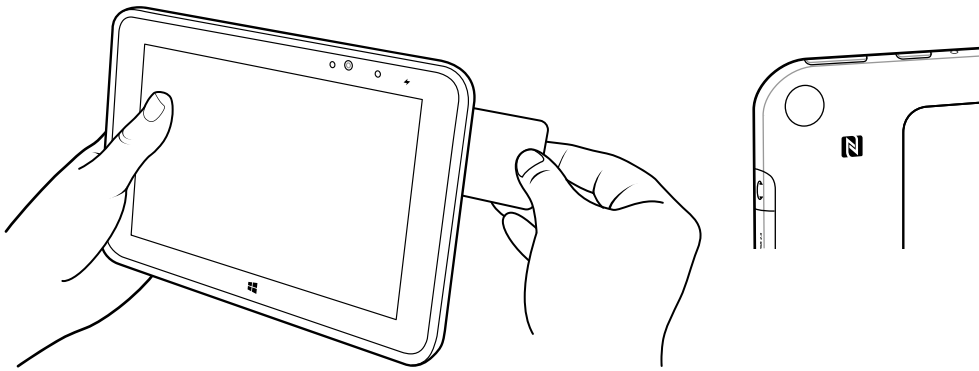
The device NFC antenna is positioned to read NFC cards from the back of the device while the device is being held.

## Reading NFC Cards

To read NFC cards:

1. Launch an NFC enabled application.
2. Hold device as shown.
3. Move the device close to the NFC card until it detects the card.
4. Hold the card steadily until the transaction is complete (usually indicated by the application).

Figure 61 Reading Cards





# Data Capture

The device supports data capture using:

- integrated camera
- integrated scanner (ET51 with Integrated Scanner only)
- SE4750 Expansion Back
- RS507 and RS507X Hands-free Imager
- RS6000 Ring Scanner
- DS3608 and DS3678 scanners
- DS2278 scanner.

## Imaging

The imager uses imaging technology to take a picture of a bar code, stores the resulting image in its memory, and executes state-of-the-art software decoding algorithms to extract the bar code data from the image.

The device with a 2D imager has the following features:

- Omnidirectional reading of a variety of bar code symbologies, including the most popular linear, postal, PDF417, and 2D matrix code types.
- Advanced intuitive laser aiming cross-hair and dot aiming for easy point-and-shoot operation.

## Scanning Considerations

Typically, scanning is a simple matter of aim, scan, and decode, with a few quick trial efforts to master it. However, consider the following to optimize scanning performance:

- **Range:** Scanners decode best over a particular working range — minimum and maximum distances from the barcode. This range varies according to barcode density and scanning device optics. Scan within range for quick and constant decodes; scanning too close or too far away prevents decodes. Move the scanner closer and further away to find the right working range for the barcodes being scanned.
- **Angle:** Scanning angle is important for quick decodes. When the illumination/flash reflects directly back into the imager, the specular reflection can blind/saturate the imager. To avoid this, scan the barcode so that the beam does not bounce directly back. Do not scan at too sharp an angle; the scanner needs to collect scattered reflections from the scan to make a successful decode. Practice quickly shows what tolerances to work within.
- Hold the device farther away for larger symbols.
- Move the device closer for symbols with bars that are close together.



**NOTE:** Scanning procedures depend on the app and device configuration. An app may use different scanning procedures from the one listed above.

## Expansion Back

The Expansion Back is a bar code scanning solutions for both 1D and 2D bar code symbologies that attach to the tablet. Expansion Back is available for the 8.4" and 10.1" tablet.

Install the Expansion Back prior to use. Refer to the ET51/56 Integration Guide for installation instructions.

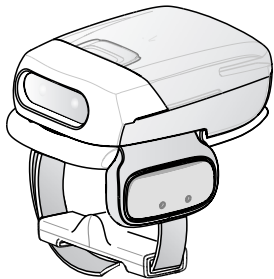
## Integrated Scanner

The ET51 Enterprise Tablet with Integrated Scanner contains a built-in 2D scan engine for both 1D and 2D bar code symbologies.

## RS507/RS507X Hands-Free Imager

The RS507/RS507X Hands-free Imager is a wearable barcode scan solution for both 1D and 2D barcode symbologies.

Figure 62 RS507/RS507X Hands-Free Imager

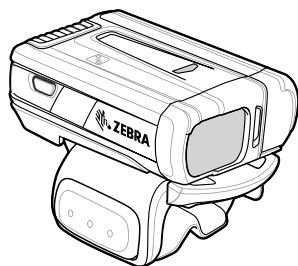


Refer to the RS507/RS507X Hands-free Imager Product Reference Guide for more information.

## RS6000 Bluetooth Ring Scanner

The RS6000 Bluetooth Ring Scanner is a wearable barcode scan solution for both 1D and 2D barcode symbologies.

Figure 63 RS6000 Bluetooth Ring Scanner

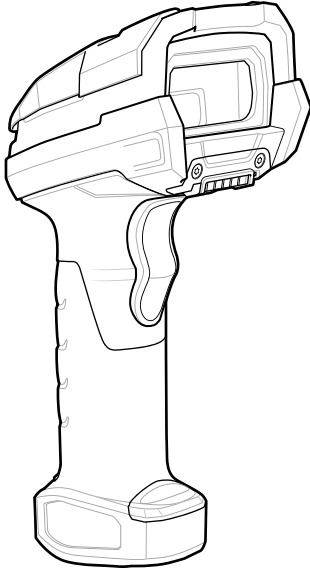


Refer to the RS6000 Bluetooth Ring Scanner Product Reference Guide for more information.

## DS3678 Digital Scanner

The cordless DS3678 combines superior 1D and 2D omnidirectional barcode scanning performance and advanced ergonomics in a lightweight design. See the DS36X8 Product Reference Guide for more information.

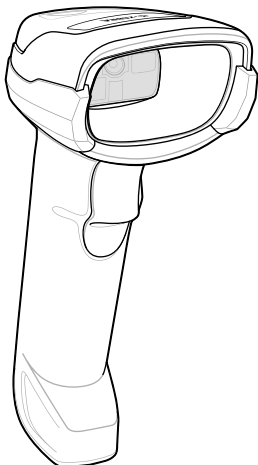
Figure 64 DS3678 Digital Scanner



## DS2278 Digital Scanner

The DS2278 digital imager scanner scans both 1D and 2D bar codes and does not compromise performance or features.

Figure 65 DS2278 Digital Scanner



Refer to the DS22788 Digital Scanner Product Reference Guide for more information.

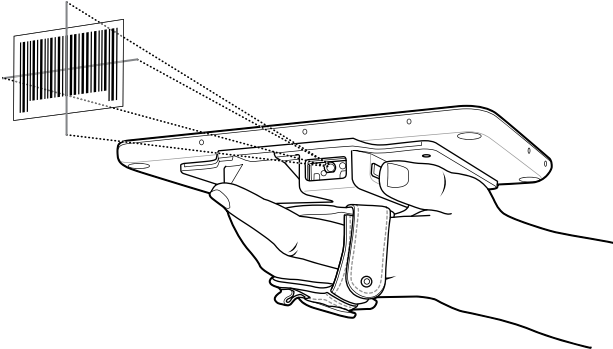
## Scanning with SE4750 Expansion Back

To read a barcode, a scan-enabled app is required. The device contains the DataWedge app that allows the user to enable the scanner to decode barcode data and display the barcode content.

To scan with the SE4750 Expansion Back:

1. Ensure that an app is open on the device and a text field is in focus (text cursor in text field).
2. Point the Expansion Back exit window at a bar code.

Figure 66 Bar Code Scanning with Expansion Back with SE4750

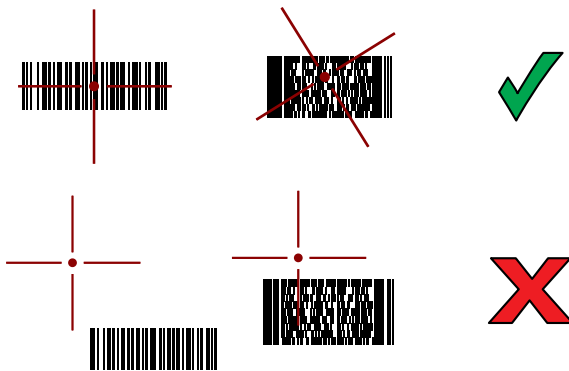


3. Press and hold the Scan button.

The red laser aiming pattern turns on to assist in aiming. Ensure the bar code is within the area formed by the cross-hairs in the aiming pattern. The aiming dot is used for increased visibility in bright lighting conditions.

The Expansion Back beeps to indicate the bar code was decoded successfully.

Figure 67 SE4750 Expansion Back Aiming Pattern



Release the Scan button. The bar code data displays on the screen.

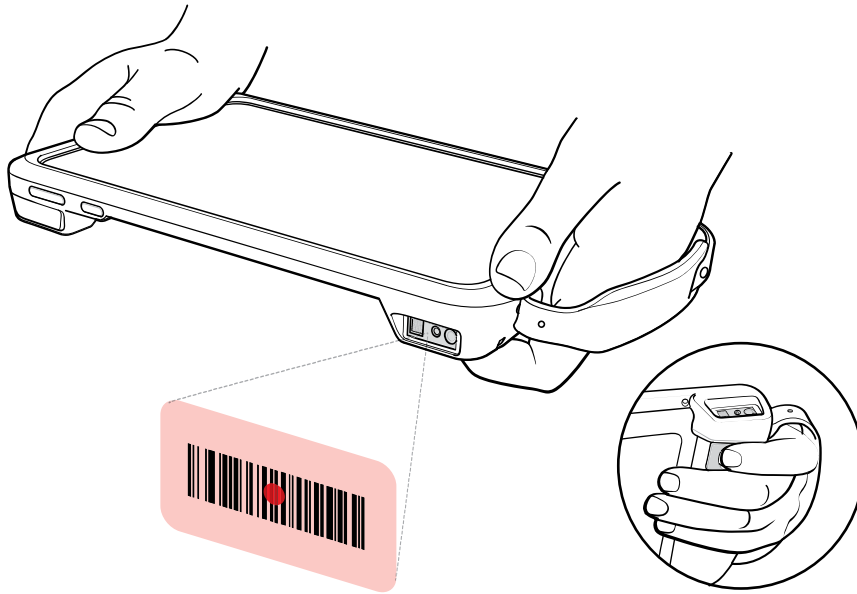
## Scanning with the Integrated Scanner

To read a barcode, a scan-enabled app is required. Devices that contain the Zebra DataWedge app allows you to enable the scanner to decode barcode data and display the barcode content.

To scan with the integrated scanner:

1. Ensure that an app is open on the device and a text field is in focus (text cursor in text field).
2. Point the device at a barcode.

Figure 68 Barcode Scanning with Integrated Scanner



3. Press and hold one of the triggers.
4. Ensure the barcode is within the area formed by the aiming pattern. The aiming dot increases visibility in bright lighting conditions.

A beep sounds to indicate the barcode was decoded successfully. When the Integrated Scanner is in Pick List mode, the device does not decode the barcode until the aiming dot touches the barcode.

Figure 69 Integrated Scanner Aiming Pattern

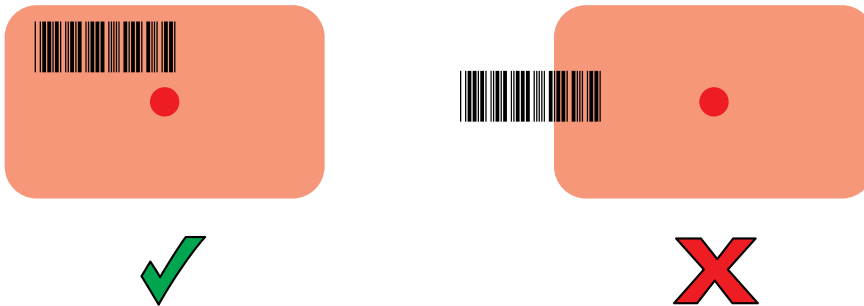
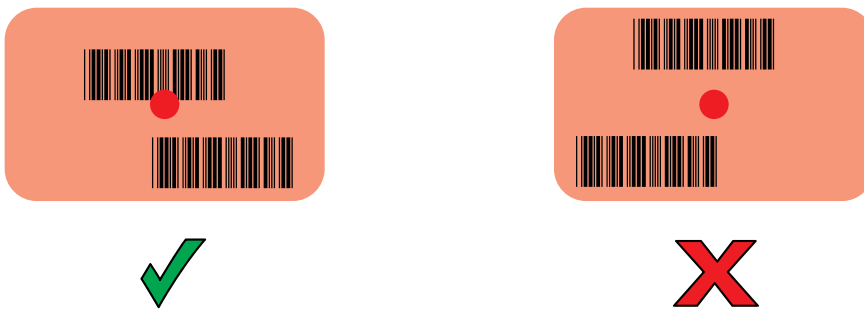


Figure 70 Integrated Scanner Pick List Mode with Multiple Barcodes in Aiming Pattern



5. The captured data appears in the text field.

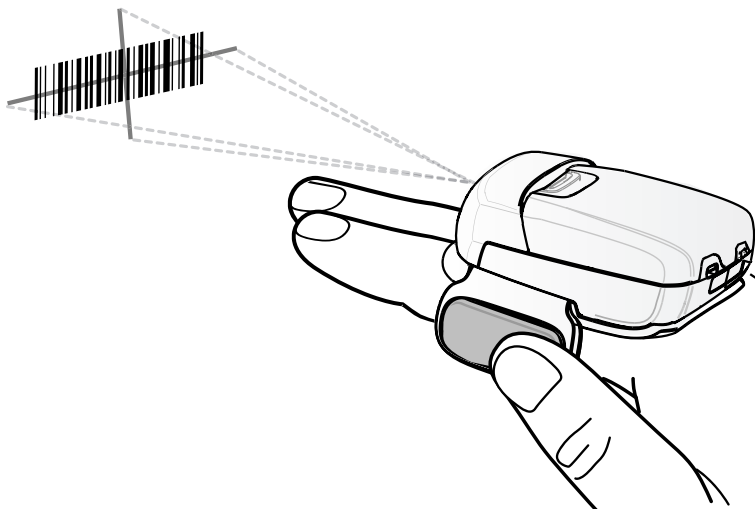
## Scanning with RS507/RS507X Hands-Free Imager

To read a barcode, a scan-enabled app is required. The device contains the DataWedge app that allows you to enable the scanner to decode barcode data and display the barcode content.

To scan with the RS507/RS507X:

1. Pair the RS507/RS507X with the device. See [Pairing Using Simple Serial Interface](#) or [Pairing Using Bluetooth Human Interface Device](#) for more information.
2. Ensure that an app is open on the device and a text field is in focus (text cursor in text field).
3. Point the RS507/RS507X at a barcode.

Figure 71 Barcode Scanning with RS507/RS507X



4. Press and hold the trigger.

The red laser aiming pattern turns on to assist in aiming. Ensure the barcode is within the area formed by the cross-hairs in the aiming pattern. The aiming dot increases visibility in bright lighting conditions.

The RS507/RS507X LEDs light green and a beep sounds to indicate the barcode was decoded successfully. When the RS507/RS507X is in Pick List mode, the RS507/RS507X does not decode the barcode until the center of the crosshair touches the barcode.

Figure 72 RS507/RS507X Aiming Pattern

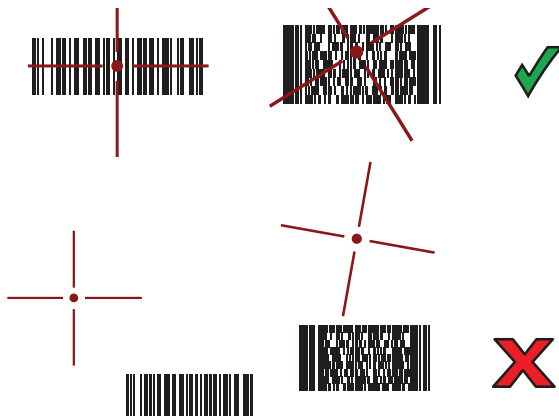


Figure 73 RS507/RS507X Pick List Mode with Multiple Barcodes in Aiming Pattern



5. The captured data appears in the text field.

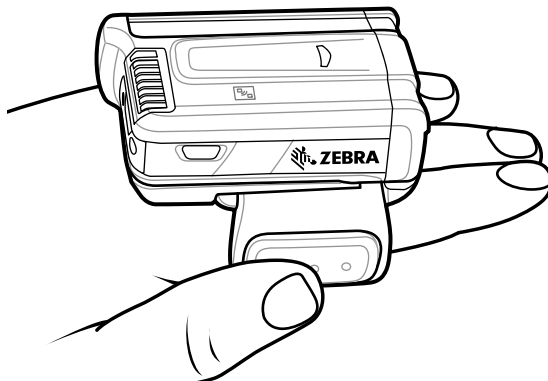
## Scanning with RS6000 Bluetooth Ring Scanner

To read a barcode, a scan-enabled app is required. Devices that contain the Zebra DataWedge app allows you to enable the scanner to decode barcode data and display the barcode content.

To scan with the RS6000:

1. Pair the RS6000 with the device. See Pairing Using Bluetooth Human Interface Device for more information.
2. Ensure that an app is open on the device and a text field is in focus (text cursor in text field).
3. Point the RS6000 at a barcode.

Figure 74 Barcode Scanning with RS6000



4. Press and hold the trigger.

The red laser aiming pattern turns on to assist in aiming. Ensure the barcode is within the area formed by the cross-hairs in the aiming pattern. The aiming dot increases visibility in bright lighting conditions.

The RS6000 LEDs light green and a beep sounds to indicate the barcode was decoded successfully. When the RS6000 is in Pick List mode, the RS6000 does not decode the barcode until the center of the crosshair touches the barcode.

Figure 75 RS6000 Aiming Pattern

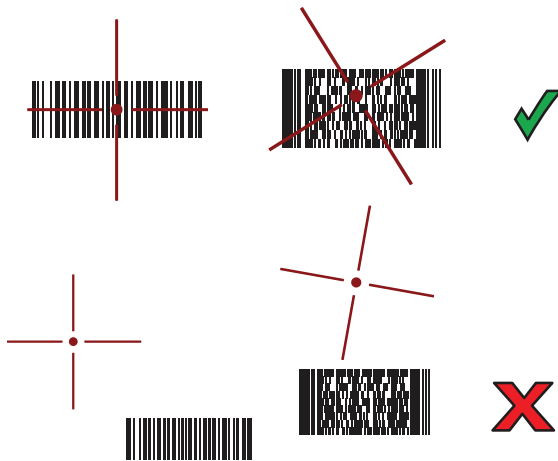


Figure 76 RS6000 Pick List Mode with Multiple Barcodes in Aiming Pattern



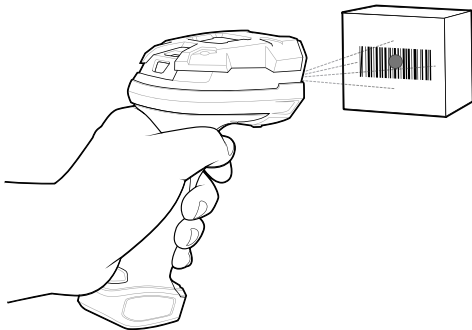
5. The captured data appears in the text field.

## Scanning with the DS3608 USB Scanner or DS3678 Bluetooth Scanner

To scan with the DS3608 or DS3678:

1. Pair the scanner with the device. For more information, see [Connecting a USB Scanner for the DS3608](#) or [Pairing Bluetooth Scanners for the DS3678](#).
2. Ensure that an app is open on the device and a text field is in focus (text cursor in text field).
3. Point the scanner at a barcode.

Figure 77 Barcode Scanning (DS3678 shown)



4. Press and hold the trigger.

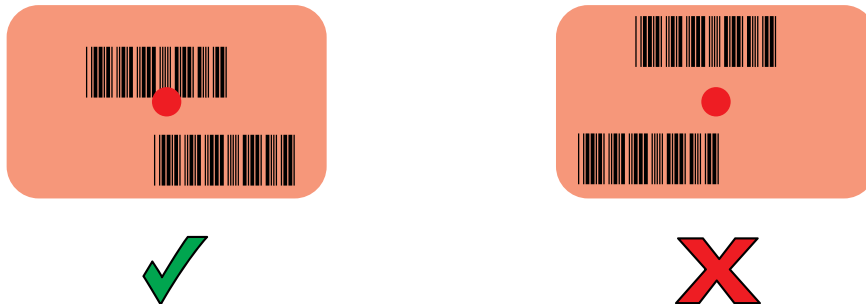


Ensure the barcode is within the area formed by the aiming pattern. The aiming dot increases visibility in bright lighting conditions.

Figure 78 DS3608/DS3678 Aiming Pattern



Figure 79 DS3608/DS3678 Pick List Mode with Multiple Barcodes in Aiming Pattern



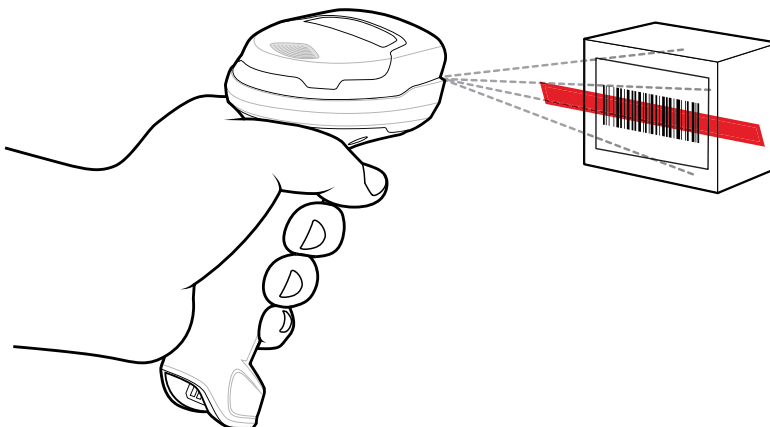
5. The captured data appears in the text field.

## Scanning with DS2278 Digital Scanner

To scan with the DS2278:

1. Pair the DS278 with the device. See [Pairing a Bluetooth Scanner on page 116](#) for more information.
2. Ensure that an app is open on the device and a text field is in focus (text cursor in text field).
3. Point the scanner at a barcode.

Figure 80 Barcode Scanning with DS2278



4. Press and hold the trigger.

5. Ensure the aiming pattern covers the barcode.

Figure 81 DS2278 Aiming Pattern



6. Upon successful decode, the scanner beeps and the LED flashes, and the scan line turns off.

7. The captured data appears in the text field.

## Pairing the RS507/RS507X/RS6000 Hands-Free Imager

To connect the RS507/RS507X or RS6000 imager to the device, use one of the following methods:

- Simple Serial Interface (SSI)
- Bluetooth Human Interface Device (HID) Mode.

### Pairing Using Simple Serial Interface (SSI)

To pair the RS507/RS507X or RS6000 with the device using SSI.


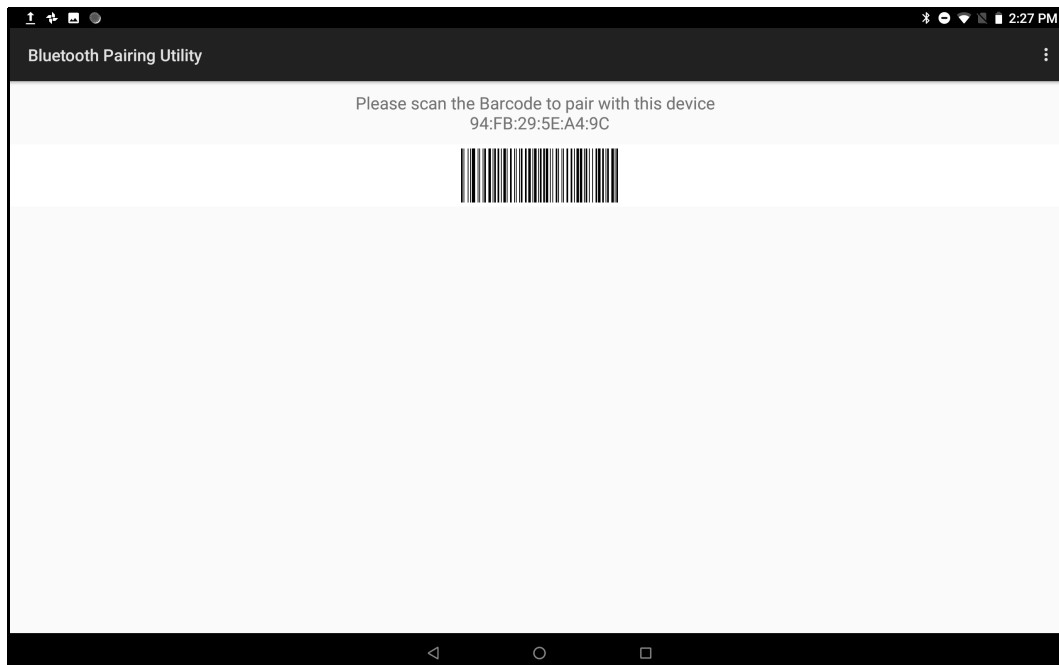

1. Swipe up from the bottom of the Home screen and touch .

Figure 82 Bluetooth Pairing Utility



- Using the RS507/RS507X or RS6000, scan the barcode on the screen.

The RS507/RS507X or RS6000 emits a string of high/low/high/low beeps. The Scan LED flashes green indicating that the RS507/RS507X or RS6000 is attempting to establish connection with the device. When connection is established, the Scan LED turns off and the RS507/RS507X or RS6000 emits one string of low/high beeps.

A notification appears on the Notification panel and the  icon appears in the Status bar.

## Pairing Using Bluetooth Human Interface Device

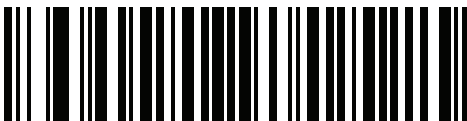
To pair the RS507/RS507X or RS6000 with the device using Human Interface Device (HID):


- Ensure that Bluetooth is enabled on both devices.
- Ensure that the Bluetooth device to discover is in discoverable mode.
- Ensure that the two devices are within 10 meters (32.8 feet) of one another.
- Place the RS507/RS507X or RS6000 in HID mode. If the RS507/RS507X or RS6000 is already in HID mode, skip to step 5.
  - Remove the battery from the RS507/RS507X or RS6000.
  - Press and hold the Restore key.
  - Install the battery onto the RS507/RS507X or RS6000.
  - Keep holding the Restore key for about five seconds until a chirp is heard and the Scan LEDs flash green.
  - Scan the barcode below to place the RS507/RS507X or RS6000 in HID mode.

Figure 83 RS507 Bluetooth HID Barcode



Figure 84 RS6000 Bluetooth HID Barcode



- Remove the battery from the RS507/RS507X or RS6000.
- Re-install the battery into the RS507/RS507X or RS6000.
- Swipe down from the Status bar to open the Quick Access panel and then touch .
- Touch **Bluetooth**.
- Touch **Pair new device**. The device begins searching for discoverable Bluetooth devices in the area and displays them under **Available devices**.
- Scroll through the list and select RS507/RS507X or RS6000.

The device connects to the RS507/RS507X or RS6000 and **Connected** appears below the device name. The Bluetooth device is added to the **Paired devices** list and a trusted (“paired”) connection is established.

A notification appears on Notification panel and the **A** icon appears in the Status bar.

## Pairing a Bluetooth Scanner

Connect the scanner to the device using one of the following methods:

- Simple Serial Interface (SSI) mode
- Bluetooth Human Interface Device (HID) mode.

### Pairing Using Simple Serial Interface

To pair the scanner with the device using SSI:


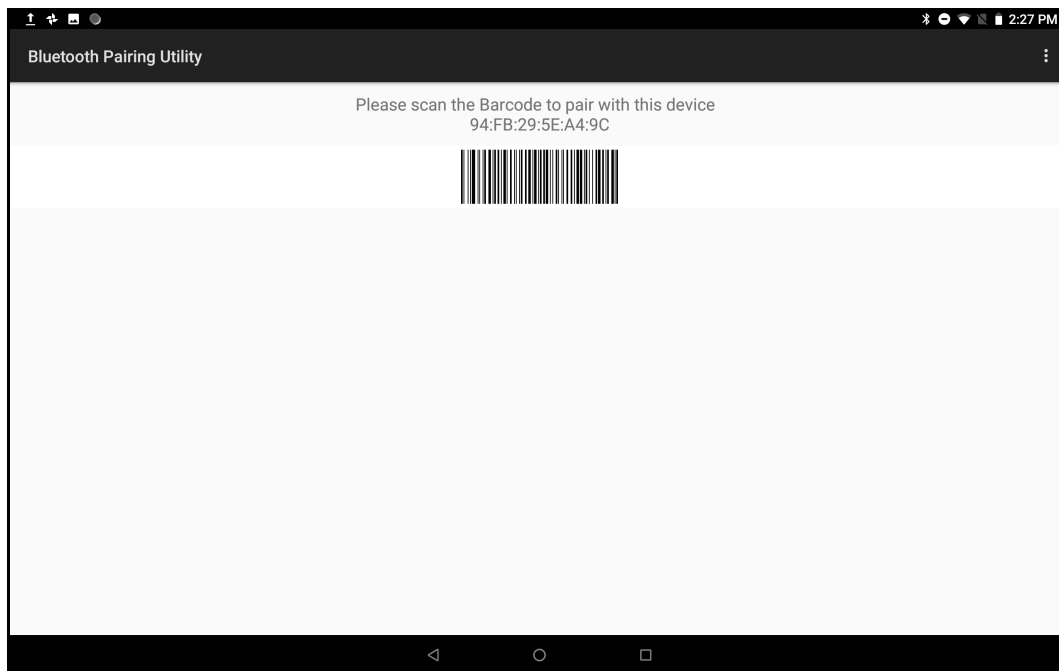
1. Ensure that the two devices are within 10 meters (32.8 feet) of one another.
2. Install the battery into the scanner.
3. On the device swipe up from the bottom of the Home screen and touch .

Figure 85 Bluetooth Pairing Utility



4. Using the scanner, scan the barcode on the screen.

The scanner emits a high/low/high/low beeps. The Scan LED flashes green indicating that the scanner is attempting to establish connection with the device. When connection is established, the Scan LED turns off and the scanner emits one string of low/high beeps.

5. On the device touch .


## Pairing Using Bluetooth Human Interface Device

To pair the scanner with the device using HID:

1. Remove the battery from the scanner.
2. Replace the battery.
3. After the scanner reboots, scan the barcode below to place the scanner in HID mode.

Figure 86 Bluetooth HID Classic Barcode



4. On the device, swipe down from the Status bar to open the Quick Access panel and then touch .
5. Touch **Bluetooth**.
6. Touch **Pair new device**. The device begins searching for discoverable Bluetooth devices in the area and displays them under **Available devices**.
7. Scroll through the list and select XXXXX xxxxxx, where XXXXX is the scanner and xxxxxx is the serial number.

The device connects to the scanner, the scanner beeps once and **Connected** appears below the device name. The Bluetooth device is added to the **Paired devices** list and a trusted (“paired”) connection is established.

## Connecting a USB Scanner

To connect a DS3608 USB scanner, use one of the following methods:

- Simple Serial Interface (SSI) mode
- Human Interface Device (HID) mode.

### Connecting Using Simple Serial Interface


To connect a USB scanner using SSI mode:

1. Connect the scanner cable USB connector to the USB port of the device (using a third-party USC-A to USB-C adapter) or to a vehicle cradle. The scanner beeps.
2. Ensure that the scanner is in SSI mode. Refer to the Refer to the DS36X8 Product Reference Guide and scan the SSI Over USB CDC barcode.

### Connecting Using HID Mode

To connect a USB scanner using HID mode:

1. Connect the scanner cable USB connector to the USB port of the device (using a third-party USC-A to USB-C adapter) or to a vehicle cradle. The scanner beeps.




- 
2. Ensure that the scanner is in HID mode. Refer to the Refer to the DS36X8 Product Reference Guide and scan the HID Keyboard barcode or perform a factory reset.

# DataWedge




DataWedge is a utility that adds advanced barcode scanning capability to any application without writing code. It runs in the background and handles the interface to built-in barcode scanners. The captured barcode data is converted to keystrokes and sent to the target application as if it was typed on the keypad.

To configure DataWedge refer to the device Integrator Guide.

## Enabling DataWedge

1. Swipe up from the bottom of the Home screen and touch .
2. Touch  > **Settings**.
3. Touch the **DataWedge enabled** checkbox. A blue checkmark appears in the checkbox indicating that DataWedge is enabled.
4. Touch .

## Disabling DataWedge

1. Swipe up from the bottom of the Home screen and touch .
2. Touch  > **Settings**.
3. Touch the **DataWedge enabled** checkbox. A blue checkmark disappears from the checkbox indicating that DataWedge is disabled.
4. Touch .

# Accessories

## Introduction

The device accessories provide a variety of product support capabilities.

**Table 14** Device Accessories

Accessory	Part Number	Description
<b>Cradles</b>		
Charge Only Cradle	CRD-ET5X-1SCG2	Charges the main battery and optional Power Pack installed in the Expansion Back. Requires power supply PWR-BGA12V50W0WW, DC line cord CBL-DC-388A1-01 and country-specific AC line cord.
Communication and Charging Cradle	CRD-ET5X-1SCOM1	Charges the main battery and optional Power Pack installed in the Expansion Back. Requires power supply PWR-BGA12V50W0WW, DC line cord CBL-DC-388A1-01, and country-specific AC line cord.
Rugged Communication and Charging Cradle	CRD-ET5X-1SCOM2R	Charges the main battery and optional Power Pack installed in the Expansion Back. Supports rugged frame and rugged IO Adapter. Requires power supply PWR-BGA12V50W0WW, DC line cord CBL-DC-388A1-01, and country-specific AC line cord.
4-Slot Charge Only Cradle	CRD-ET5X-SE4CO2-01	Charges up to four main batteries and optional Power Pack installed in the Expansion Back and up to four Power Packs in the optional 4-Slot Battery Charger. Requires power supply PWR-BGA12V108W0WW, DC line cord CBL-DC-388A1-01, and country-specific AC line cord.
<b>Chargers</b>		
Power Supply	PWR-BGA12V108W0WW	Provides power to the 4-Slot Charge Only Cradle.



**Table 14** Device Accessories (Continued)

Accessory	Part Number	Description
Power Supply	PWR-BGA12V50W0WW	Provides power to the Charge Only Cradle, Communication and Charging Cradle, Rugged Communication and Charging Cradle, and 4-Slot Battery Charger for Optional Battery Power Pack.
Power Supply	PWR-WUA5V12W0xx Where xx: AR = Argentina AU = Australia BR = Brazil CN = China EU = European Union Countries GB = Great Britain IN = India KR = Korea US = United States	Provides power to the tablet using the USB-C cable CBL-TC2X-USBC-01.
4-Slot Battery Charger	SAC-ET5X-4PPK1-01	Chargers up to four Power Packs. Requires power supply PWR-BGA12V50W0WW, DC Line cord CBL-DC-388A1-01, and country-specific AC line cord.
Rugged Charge Connector	CHG-ET5X-CBL2-01	Charges the main battery and optional Power Pack installed in the Expansion Back. Requires power supply PWR-BGA12V50W0WW, DC Line Cord CBL-DC-388A1-01 and country-specific AC line cord.
<b>Miscellaneous</b>		
Replacement 8.4" Internal Battery	BTRY-ET5X-8IN5-01	Replacement battery for 8.4" tablet.
Replacement 10.1" Internal Battery	BTRY-ET5X-10IN5-01	Replacement battery for 10.1" tablet.
Replacement 8.4" Battery Cover	KT-ET5X-8BTDR2-01	Replacement battery cover for 8.4" tablet.
Replacement 10.1" Battery Cover	KT-ET5X-10BTDR2-01	Replacement battery cover for 10.1" tablet.
8.4" Rugged Frame with IO Adapter	SG-ET5X-8RCSE2-02	Add extra protection for the 8.4" tablet and IO Adapter for connection to the Rugged Communication and Charging Cradle.
10.1" Rugged Frame with IO Adapter	SG-ET5X-10RCSE2-01	Add extra protection for the 10.1" tablet and IO Adapter for connection to the Rugged Communication and Charging Cradle.
Replacement Rugged IO Connector	SG-ET5X-RGIO2-01	Replacement rugged IO connector for the Rugged Frames.

**Table 14** Device Accessories (Continued)

Accessory	Part Number	Description
8.4" SE4750 Expansion Back	ZBK-ET5X-8SCN5-01	Provides data capture using the SE4750 scan engine, rotating hand strap and slot for optional Power Pack.
8.4" Expansion Back	ZBK-ET5X-8RH1-01	Provides rotating hand strap and slot for optional Power Pack.
10.1" SE4750 Expansion Back	ZBK-ET5X-10SCN5-01	Provides data capture using the SE4750 scan engine, rotating hand strap and slot for optional Power Pack.
10.1" Expansion Back	ZBK-ET5X-10RH1-01	Provides rotating hand strap and slot for optional Power Pack.
Power Pack	BTRY-ET5X-PRPK1-01	Provides additional power for charging the device battery using an Expansion Back.
Passive Stylus	SG-TC7X-STYLUS-03	Provides easy writing, drawing, and navigation and accuracy with the thin tip and hovering capabilities.
Replacement Expansion Back Hand Strap	SG-ET5X-RHTP1-01	Replacement hands strap for Expansion Backs.
Coiled Stylus Tether	SG-ET5X-SLTETR-01	Secures a stylus to the hand strap.
8.4" Operations Case	SG-ET5X-8HLST-01	Provides carrying solution for 8.4" tablet.
10.1" Operations Case	SG-ET5X-10HLST-01	Provides carrying solution for 10.1" tablet.
Breakaway Shoulder Strap	SG-ET5X-SHDRSTP-01	Use with the Operations Case and D-clips to carry tablet on shoulder.

## Charge Only Cradle



**CAUTION:** Ensure that you follow the guidelines for battery safety described in [Battery Safety Guidelines](#).



**NOTE:** The Charge Only Cradle (CRD-ET5X-1SCG2) comes with two inserts; tall insert and short insert. Install the tall insert when using a device without a Rugged Frame or Expansion Back. Install the short insert when using with an Expansion Back and without a Rugged Frame.

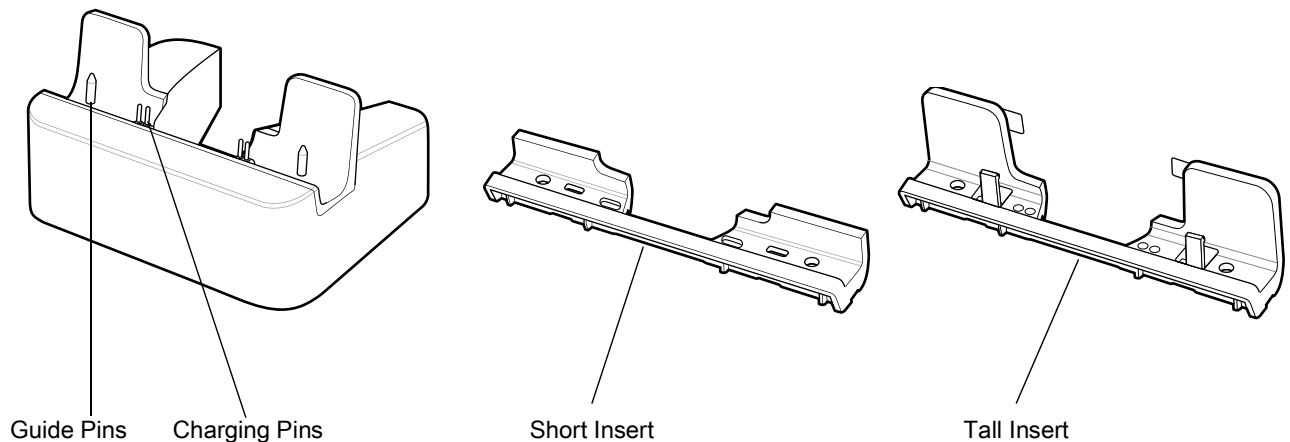
The Charge Only Cradle does not support the ET51 Enterprise Tablet with Integrated Scanner.

This section describes how to use a Charge Only Cradle with the device.

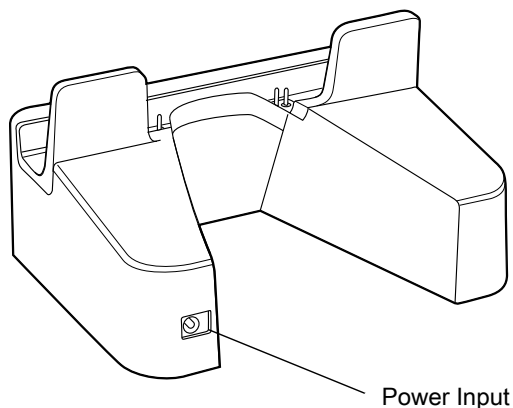
The Charge Only Cradle:

- Provides power for operating the device.
- Charges the device's battery and optional Power Pack installed in an Expansion Back.

**Figure 87** Charge Only Cradle - Front View



**Figure 88** Charge Only Cradle - Rear View

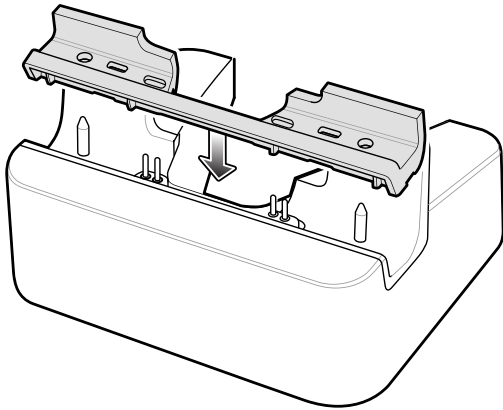


### Installing the Short Insert

Install the short insert when using an device with an Expansion Back and without a Rugged Frame.

1. Align the insert over the pins.

**Figure 89** Align Insert with Cradle

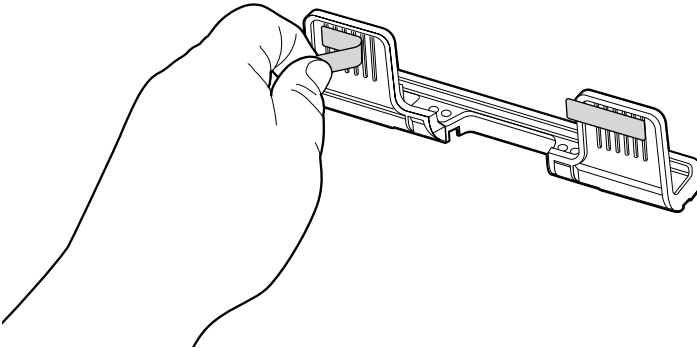


2. Press the insert down until it seats flush in the cradle.

## Installing the Tall Insert

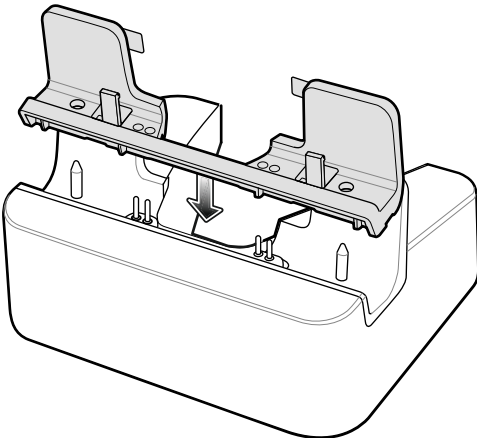
Install the tall insert when using a device without a Rugged Frame or Expansion Back.

1. Peel the tape off the back of the insert.



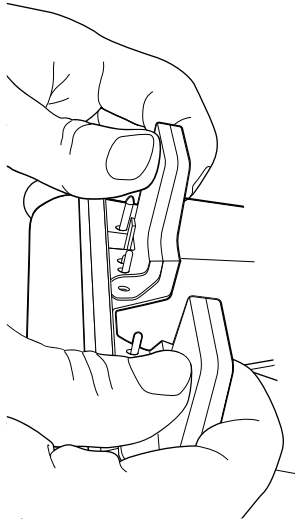
2. Align the tall insert over the pins.

**Figure 90** Align Insert with Cradle



3. Press the insert down until it seats flush in the cradle.

4. Press the tabs against the cradle to secure the insert to the cradle.



## Charging the Device

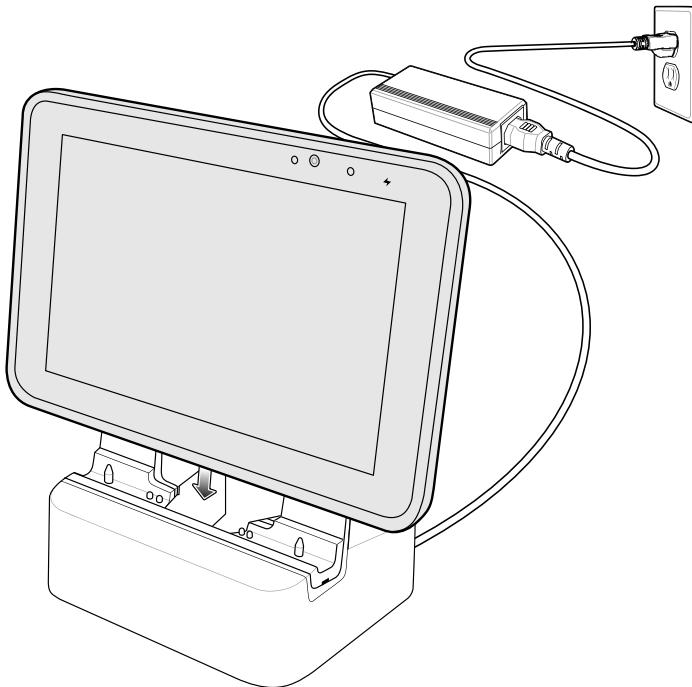
To charge the device in the Charge Only Cradle:

1. Align the device with the alignment pins on the cradle.
2. Insert the device into the cradle.



**NOTE:** Ensure the tablet is flat on the cradle and all charging contacts are touching the charging base.

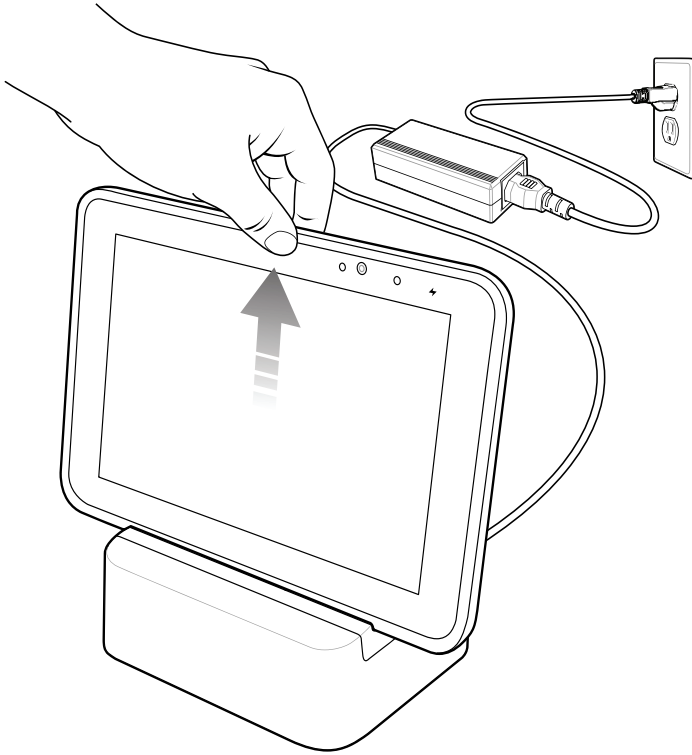
**Figure 91** Insert device into Charge Only Cradle



3. The device Charging LED indicates charging.

- To remove the device from the Charge Only Cradle, hold the cradle down with one hand and lift the device.

**Figure 92** Remove device from Charge Only Cradle



Charge batteries in ambient temperatures from 0°C to +40°C (32°F to 104°F) as reported by the battery. Charging is intelligently controlled by the charger. To accomplish this, for small periods of time, the charger alternately enables and disables battery charging to keep the battery at acceptable temperatures.

The 8.4" tablet main battery charges from fully depleted to 90% in approximately 2 hours and from fully depleted to 100% in approximately 3 hours.

The 10.1" tablet main battery charges from fully depleted to 90% in approximately 3 hours and from fully depleted to 100% in approximately 5 hours.



**NOTE:** The Charging indicator only illuminates when the device is connected to AC power.

**Table 15** Charging Indicator

LED	Indication
Off	Device is not in cradle; not seated properly; or cradle is not powered.
Blinking amber	Device is charging.
Green	Charging complete.
Red	Error in charging; check placement of the device.

## Communication and Charging Cradle



**CAUTION:** Ensure that you follow the guidelines for battery safety described in [Battery Safety Guidelines on page 144](#).



**NOTE:** The Communication and Charging Cradle (CRD-ET5X-1SCOM2) comes with two inserts; tall insert and short insert. Install the tall insert when using without a Rugged Frame or Expansion Back. Install the short insert when using with an Expansion Back and without a Rugged Frame.

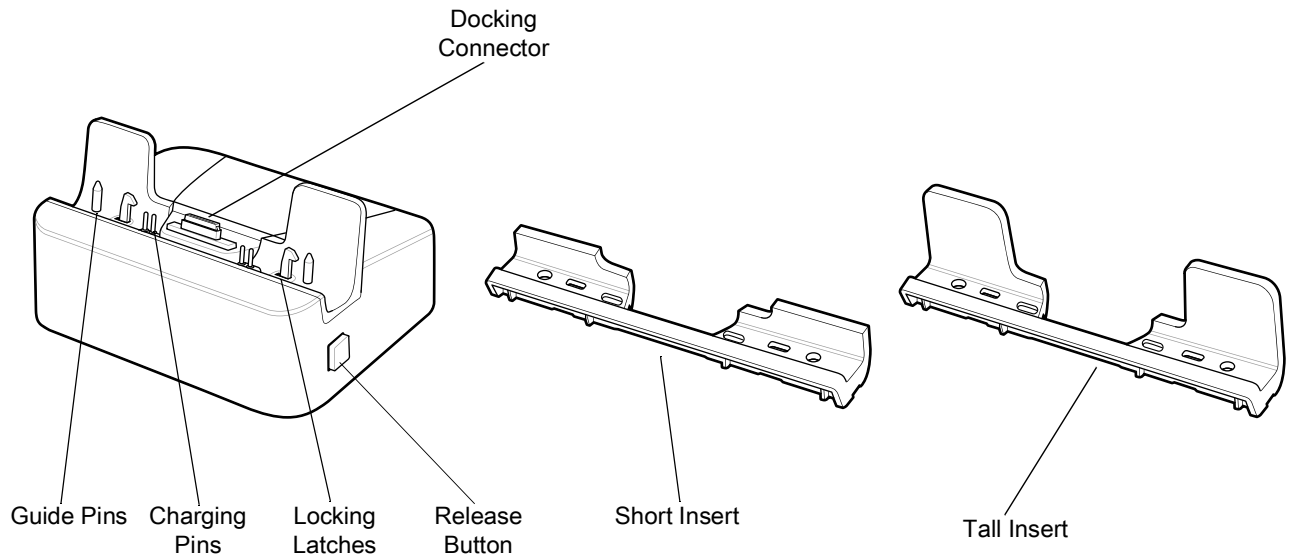
The Communication and Charging Cradle does not support the ET51 Enterprise Tablet with Integrated Scanner.

This section describes how to use a Communication and Charging Cradle with the tablet.

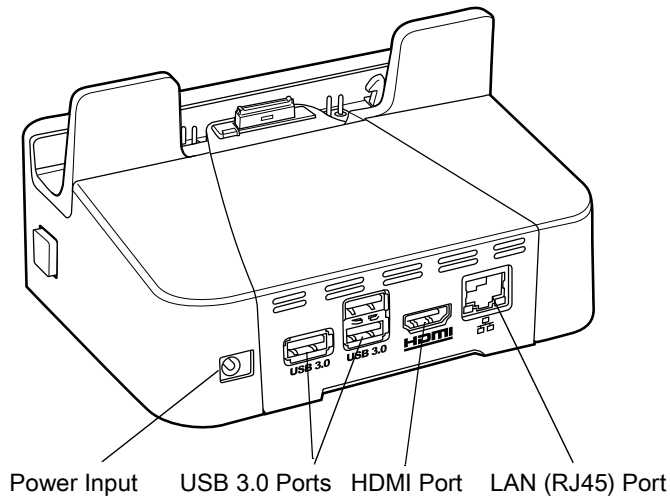
The Communication and Charging cradle:

- Provides power for operating the tablet.
- Provides ports for connecting USB devices to the tablet, video output and connection to a LAN.
- Charges the tablet's battery and optional Power Pack installed in an Expansion Back.

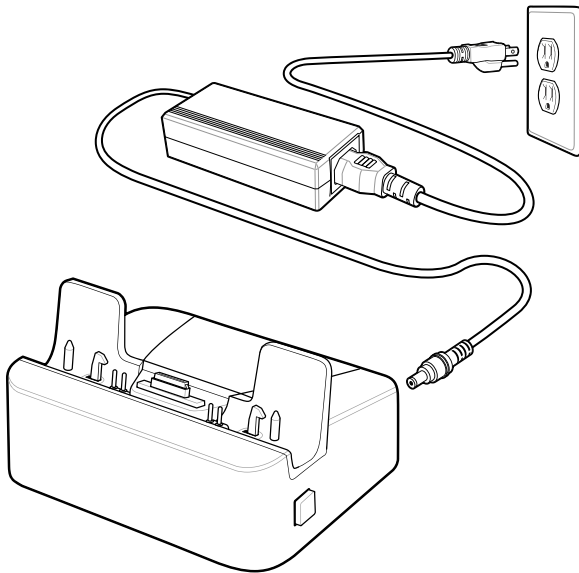
**Figure 93** Communication and Charging Cradle - Front View



**Figure 94** Communication and Charging Cradle - Rear View



**Figure 95** Communication and Charging Cradle - Setup

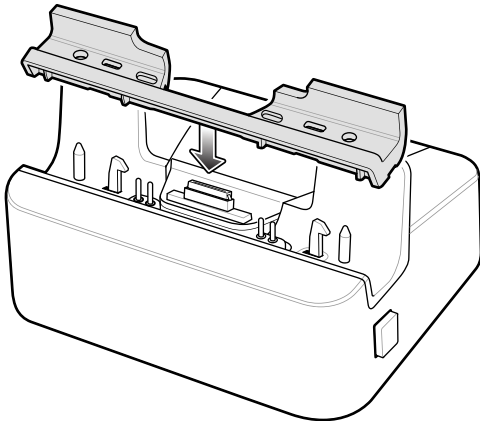


## Installing the Insert

Install the tall insert when using a device without a Rugged Frame or Expansion Back. Install the short insert when using a device with an Expansion Back and without a Rugged Frame.

1. Align the insert over the pins.



**Figure 96** Align Insert with Cradle

2. Press the insert down until it seats flush in the cradle.

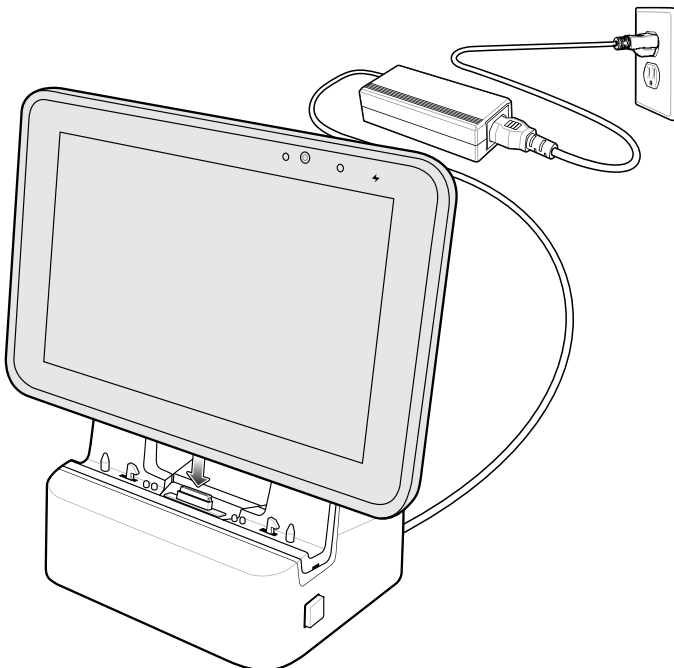
## Charging the Device

To charge the device in the Communication and Charging Cradle:

1. Open the bottom access door and hold it to the back of the tablet.
2. Align the device with the alignment pins on the cradle.
3. Insert the device into the cradle. Note that the Communication and Charging Cradles contains a locking mechanism that locks the device to the cradle.



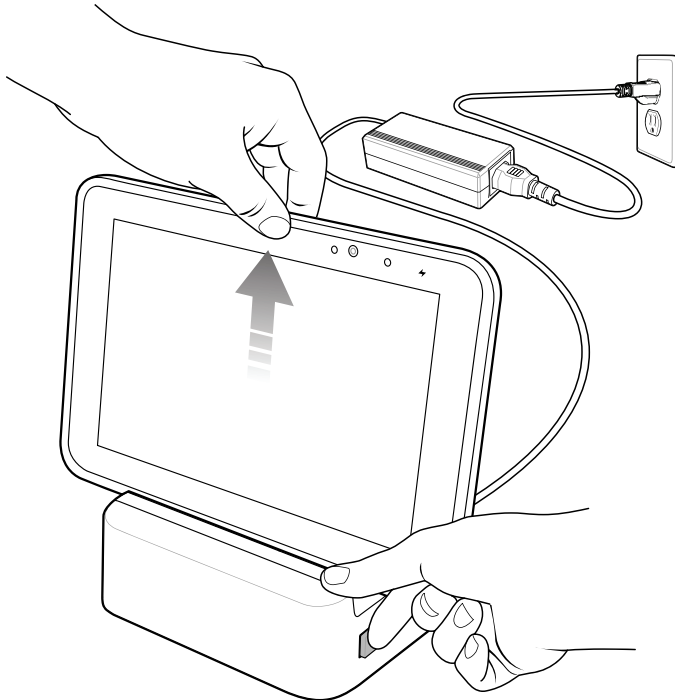
**NOTE:** Ensure the tablet is flat on the cradle and all charging contacts are touching the charging base.

**Figure 97** Insert device into Communication and Charging Cradle

4. The device Charging LED indicates charging.

5. To remove the device from the Communication and Charging Cradle, press the release button on the right side of the cradle and lift the device. Use thumb to hold down the cradle.

**Figure 98** Remove ET5X from Communication and Charging Cradles



Charge batteries in ambient temperatures from 0°C to +40°C (32°F to 104°F) as reported by the battery. Charging is intelligently controlled by the charger. To accomplish this, for small periods of time, the charger alternately enables and disables battery charging to keep the battery at acceptable temperatures.

The 8.4" tablet main battery charges from fully depleted to 90% in approximately 2 hours and from fully depleted to 100% in approximately 3 hours.

The 10.1" tablet main battery charges from fully depleted to 90% in approximately 3 hours and from fully depleted to 100% in approximately 5 hours.



**NOTE:** The Charging indicator only illuminates when the device is connected to AC power.

## Rugged Communication and Charging Cradle



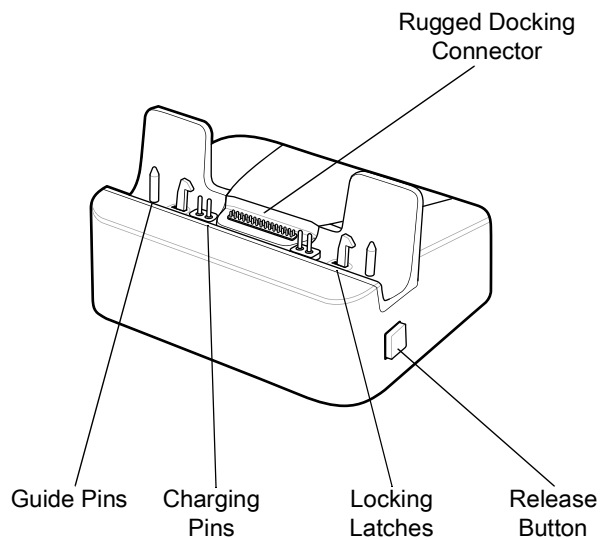
**CAUTION:** Ensure that you follow the guidelines for battery safety described in [Battery Safety Guidelines](#).

This section describes how to use a Rugged Communication and Charging Cradle with the device.

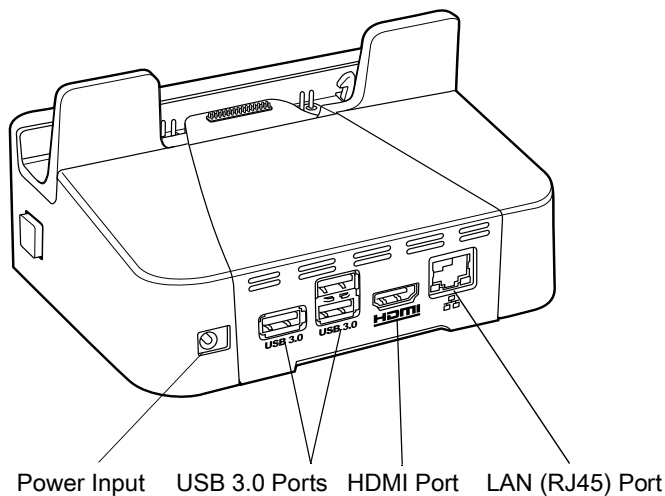
The Rugged Communication and Charging cradle:

- Provides power for operating the device.
- Provides ports for connecting USB devices to the tablet, video output and connection to a LAN.
- Charges the device's battery and optional Power Pack installed in an Expansion Back.
- Support the ET51 Enterprise Tablet with Integrated Scanner.

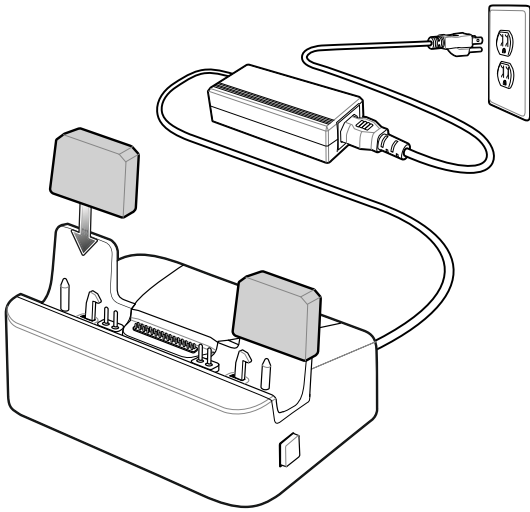
**Figure 99** Rugged Communication and Charging Cradle - Front View



**Figure 100** Rugged Communication and Charging Cradle - Rear View



For the ET51 Enterprise Tablet with Integrated Scanner, ensure that the cradle pads are installed prior to inserting the device into the cradle.

**Figure 101** Install Pads onto Cradle

## Charging the Device

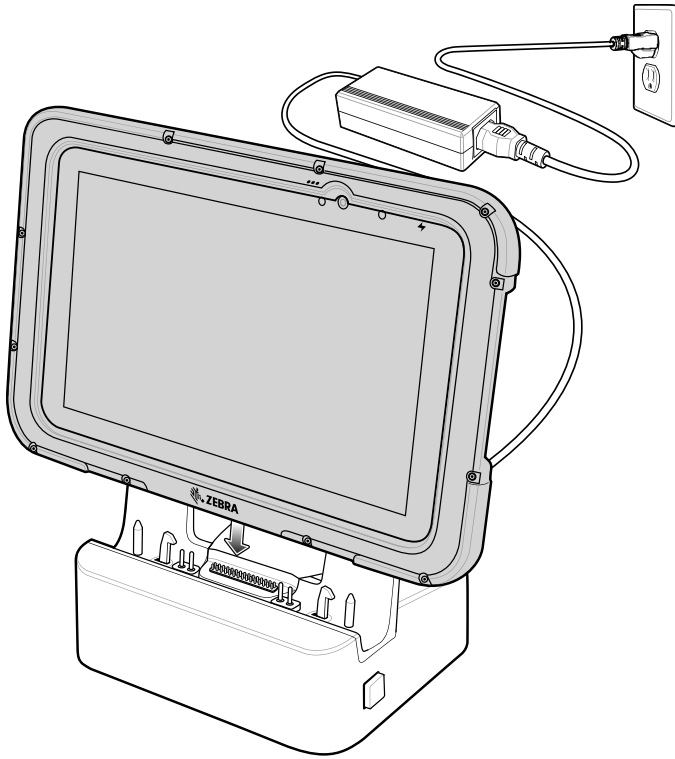
To charge the device using the Rugged Communication and Charging Cradle:

1. Align the device with the alignment pins on the cradle.
2. Insert the device into the cradle. Note that the Rugged Communication and Charging Cradles contains a locking mechanism that locks the device to the cradle.



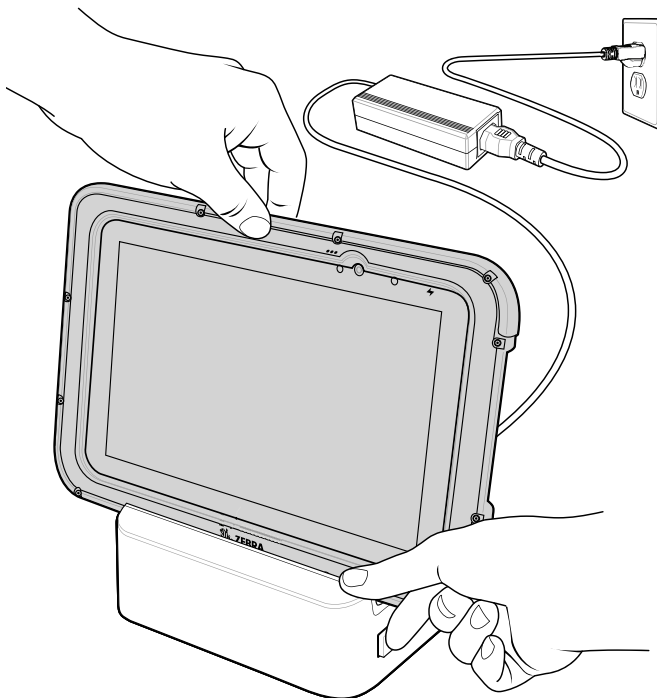
**NOTE:** Ensure the tablet is flat on the cradle and all charging contacts are touching the charging base.

**Figure 102** Insert Rugged Frame device and IO Adapter into Rugged Communication and Charging Cradle



3. The device Charging LED indicates charging.
4. To remove the device from the Rugged Communication and Charging Cradle, press the release button on the right side of the cradle and lift the device. Use thumb to hold down the cradle.

**Figure 103** Remove device from Rugged Communication and Charging Cradles



Charge batteries in ambient temperatures from 0°C to +40°C (32°F to 104°F) as reported by the battery. Charging is intelligently controlled by the charger. To accomplish this, for small periods of time, the charger alternately enables and disables battery charging to keep the battery at acceptable temperatures.

The 8.4" tablet main battery charges from fully depleted to 90% in approximately 2 hours and from fully depleted to 100% in approximately 3 hours.

The 10.1" tablet main battery charges from fully depleted to 90% in approximately 3 hours and from fully depleted to 100% in approximately 5 hours.



**NOTE:** The Charging indicator only illuminates when the device is connected to AC power.

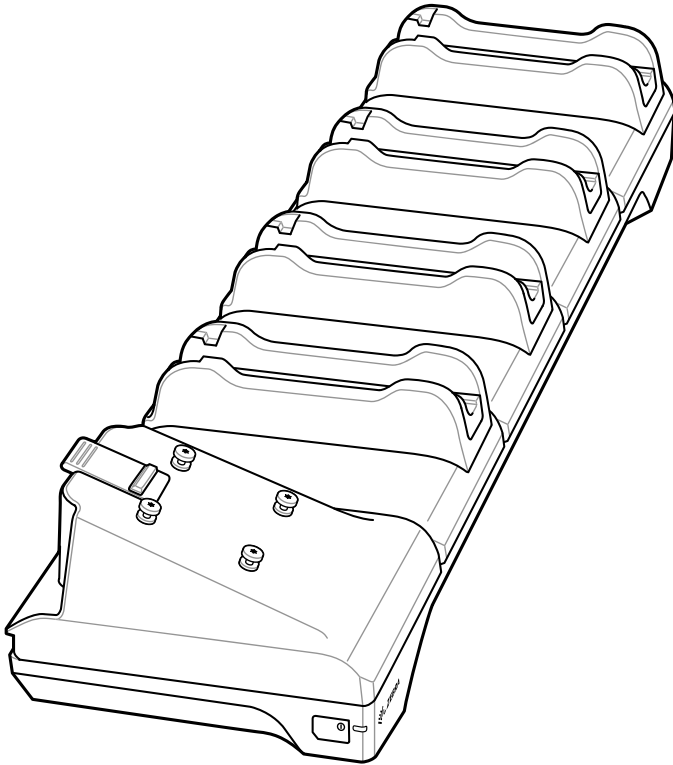
## 4-Slot Charge Only Cradle



**CAUTION:** Ensure that you follow the guidelines for battery safety described in [Battery Safety Guidelines](#).

- Provides 5 VDC power for operating the device.
- Simultaneously charges up to four devices and up to four Power Packs using the optional Battery Charger Adapter. See the ET51/56 Integrator Guide for information on installing the 4-Slot Battery Charger onto the cradle.

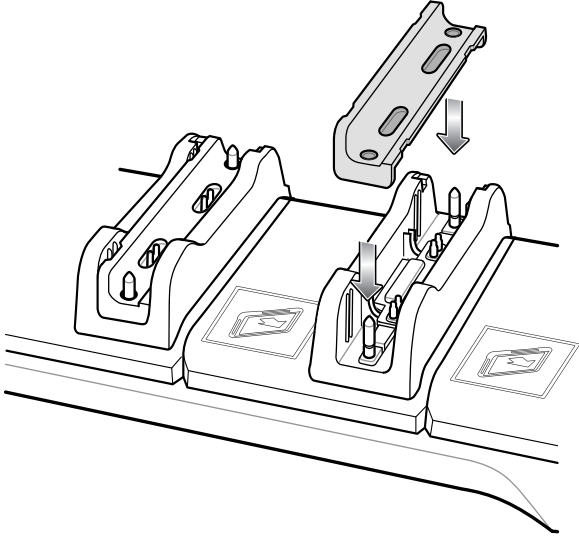
**Figure 104** 4-Slot Charge Only Cradle



## Insert Installation

Install inserts into slots for device tablets without Rugged Frame.

**Figure 105** Install Insert in Slot

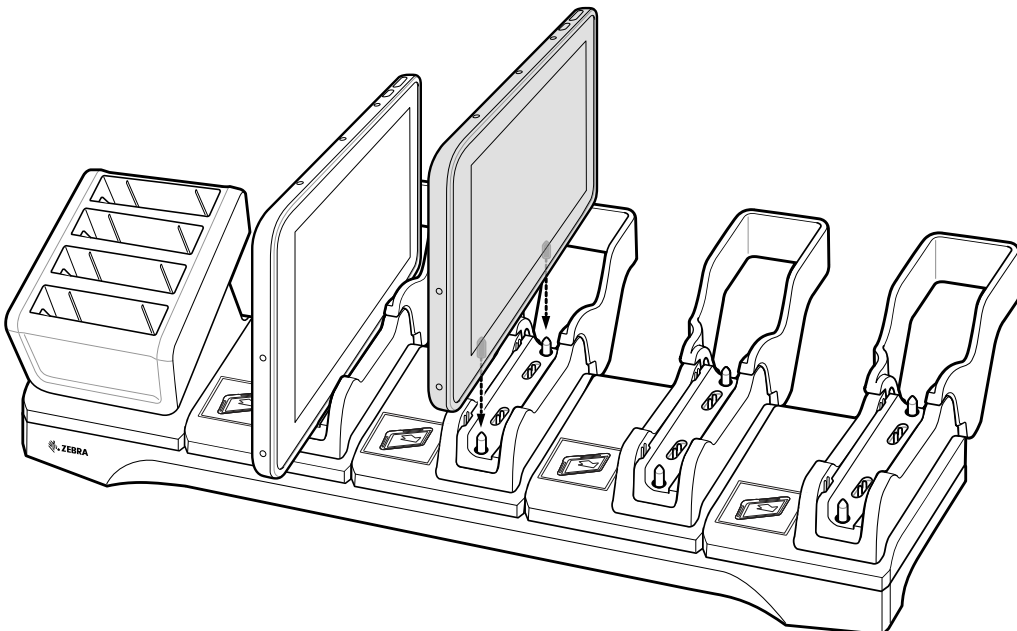


## Insert Tablet into Slot

### Device without Rugged Frame

1. Install insert into slot.
2. Align the two alignment holes on the bottom of the tablet with the two alignment pins in the slot.

**Figure 106** Insert ET5X without Rugged Frame into Slot





- Place the device down into the slot with display facing away from Battery Charger.

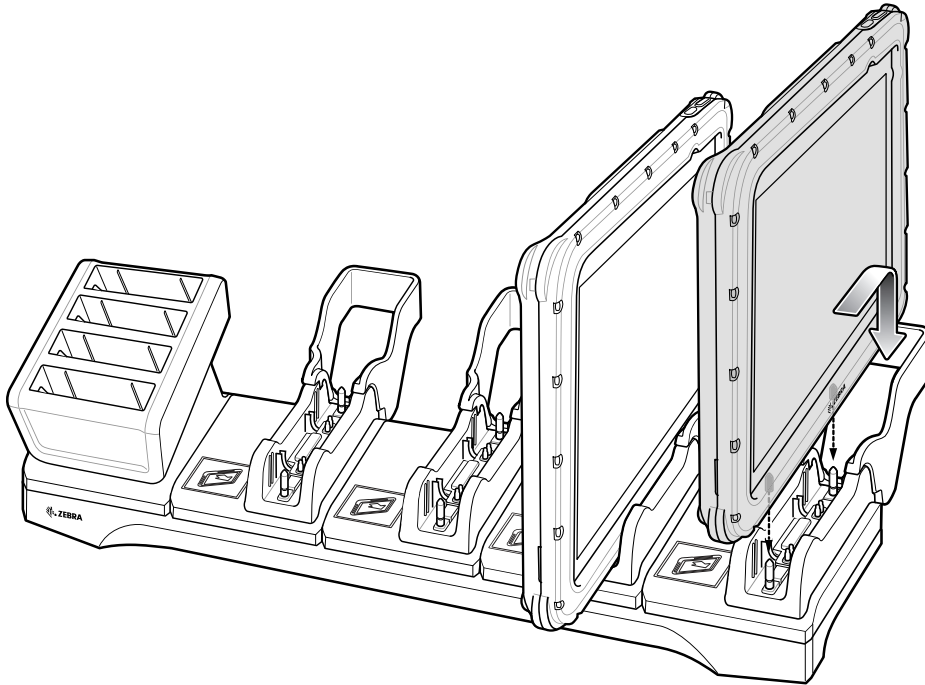


**NOTE:** There are rubs on the insert that prevent the tablet from being inserted in the wrong orientation.

### Device with Rugged Frame

- If applicable, remove insert from slot.
- Slide device over slot into it touches the guide.

**Figure 107** Insert device with Rugged Frame into Slot



- Place the device down into the slot with display facing away from Battery Charger.



**NOTE:** There are rubs on the slot that prevent the tablet from being inserted in the wrong orientation.

### Charging the Battery

Charge batteries in ambient temperatures from 0°C to +40°C (32°F to 104°F) as reported by the battery. Charging is intelligently controlled by the charger. To accomplish this, for small periods of time, the charger alternately enables and disables battery charging to keep the battery at acceptable temperatures.

The 8.4" tablet main battery charges from fully depleted to 90% in approximately 2 hours and from fully depleted to 100% in approximately 3 hours.

The 10.1" tablet main battery charges from fully depleted to 90% in approximately 3 hours and from fully depleted to 100% in approximately 5 hours.



**NOTE:** The Charging indicator only illuminates when the device is connected to AC power.

## Rugged Charge Connector



**CAUTION:** Ensure that you follow the guidelines for battery safety described in [Battery Safety Guidelines](#).

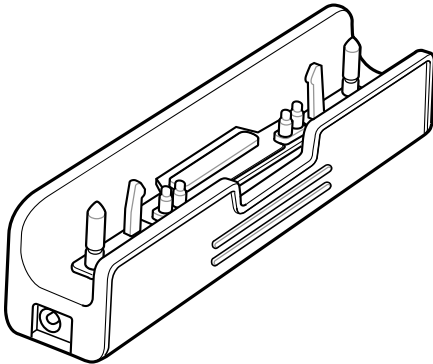
Use the Rugged Charge Connector to charge a device tablet.



**NOTE:** The Rugged Charge Connector does not support the ET51 Enterprise Tablet with Integrated Scanner.

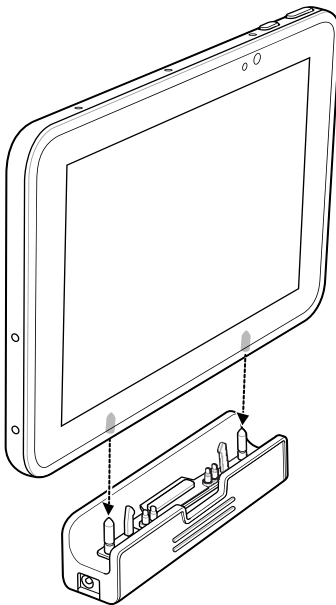
The Rugged Connector does not support the ET51 Enterprise Tablet with Integrated Scanner.

**Figure 108** Rugged Charge Connector

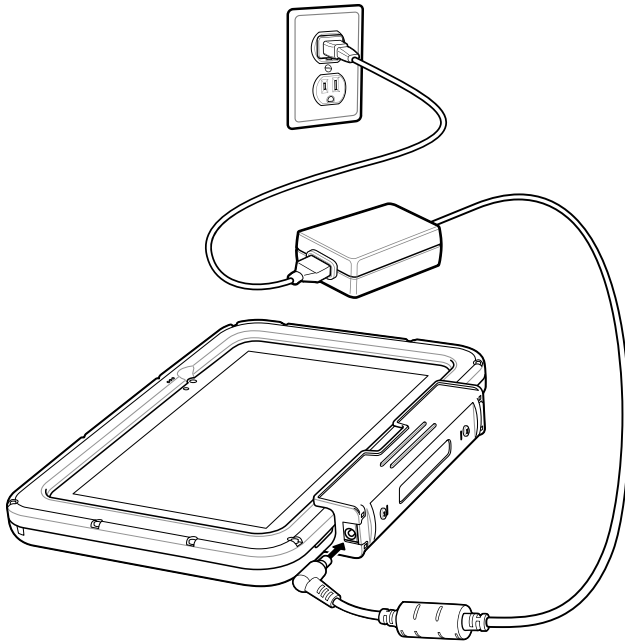


1. Align the pins in the Rugged Charge Connector with the slots in the device.

**Figure 109** Insert ET5X into Rugged Charge Connector



2. Plug the Power Supply connector into the Power Input Port on the Rugged Charge Connector.

**Figure 110** Plug Power Supply into Input Power Port

Charge batteries in ambient temperatures from 0°C to +40°C (32°F to 104°F) as reported by the battery. Charging is intelligently controlled by the charger. To accomplish this, for small periods of time, the charger alternately enables and disables battery charging to keep the battery at acceptable temperatures.

The 8.4" tablet main battery charges from fully depleted to 90% in approximately 2 hours and from fully depleted to 100% in approximately 3 hours.

The 10.1" tablet main battery charges from fully depleted to 90% in approximately 3 hours and from fully depleted to 100% in approximately 5 hours.

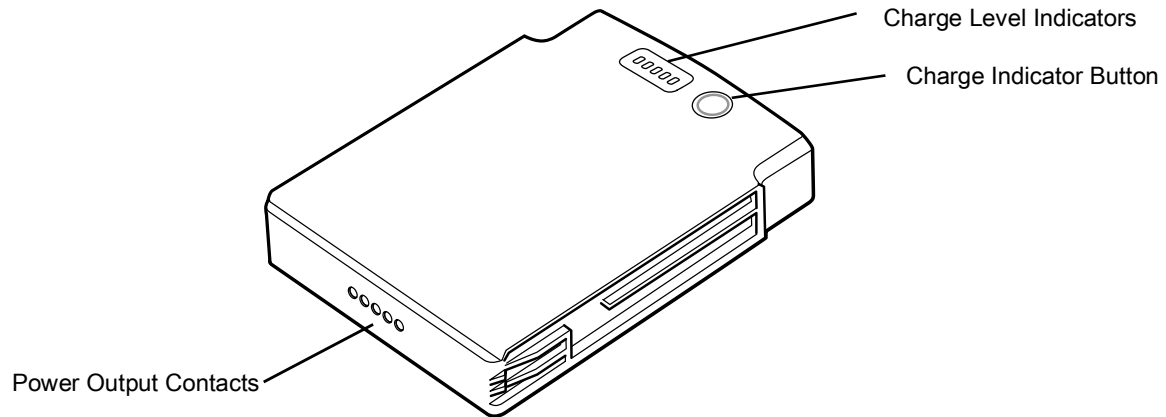


**NOTE:** The Charging indicator only illuminates when the device is connected to AC power.

## Power Pack

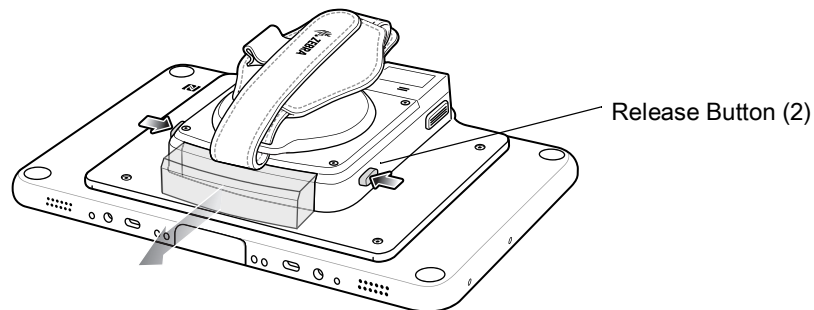
The optional Power Pack provides additional power for charging the main battery.

**Figure 111** Power Pack



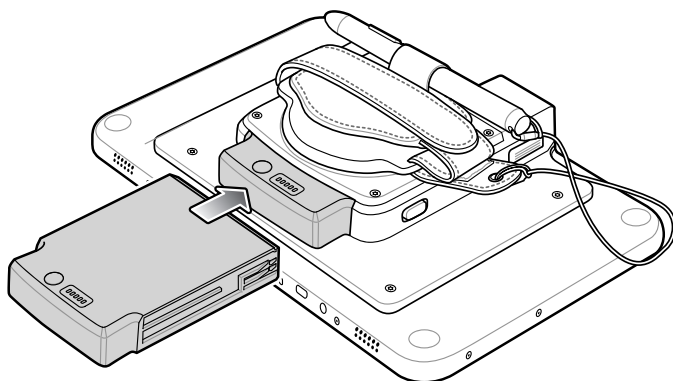
1. Install one of the optional Expansion Backs. See ET51/56 Integrator Guide for more information.
2. Press the two release buttons on the side of the Expansion Back. The dummy battery insert ejects slightly.

**Figure 112** Remove Dummy Battery Insert



3. Remove dummy battery insert.
4. Insert Power Pack into slot until it snaps into place.

**Figure 113** Install Power Pack



## Charging the Power Pack

Charge the Power Pack using:

- A cradle
- 4-Slot Charger.

### Using Cradle

With the Power Pack installed in an Expansion Back, place the device into a cradle. The Power Pack charges in less than 3.5 hours.

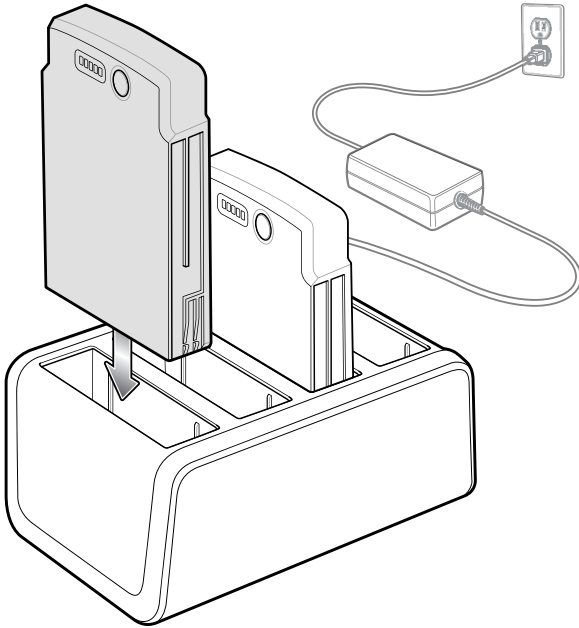
## Using the 4-Slot Battery Charger



**CAUTION:** Ensure that you follow the guidelines for battery safety described in [Battery Safety Guidelines](#).

Use the 4-Slot Battery Charger to charge up to four Power Packs.

**Figure 114** 4-Slot Battery Charger

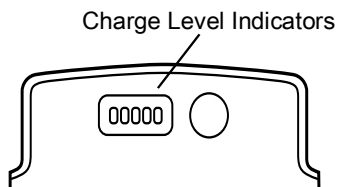


## Charging the Power Pack

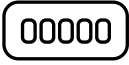
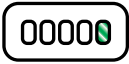





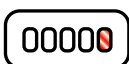



Charge Power Packs in ambient temperatures from 0°C to +40°C (32°F to 104°F) as reported by the Power Pack. Charging is intelligently controlled by the charger. To accomplish this, for small periods of time, the charger alternately enables and disables Power Pack charging to keep the battery at acceptable temperatures.

The Power Pack charge LED shows the status of the battery charging. The Power Pack charges in less than three hours. When charging, the Charge LEDs indicate the charge level.

**Figure 115** Power Pack Charge LEDs



**Table 16** Power Pack Charge Status Indicators

Power Pack Indicators	Description
	Power not applied to Power Pack.
	Charge level is between 0% and 20%.
	Charge level is between 20% and 40%.
	Charge level is between 40% and 60%.
	Charge level is between 60% and 80%.
	Charge level is between 80% and 100%.
	Fully charged.
	Charging error.
	Solid Green LED
	Blinking Green LED
	Blinking Red LED

# Maintenance and Troubleshooting

## Introduction

This chapter includes instructions on cleaning and storing the tablet, battery maintenance and provides troubleshooting solutions for potential problems during tablet operations.

## Maintaining the Device

For trouble-free service, observe the following tips when using the device:

- In order to avoid scratching the screen, use a Zebra approved capacitive touch panel compatible stylus intended for use with a touch-sensitive screen. Never use an actual pen or pencil or other sharp object on the surface of the device screen.
- The touch-sensitive screen of the device is glass. Do not drop the device or subject it to strong impact.
- Protect the device from temperature extremes. Do not leave it on the dashboard of a car on a hot day, and keep it away from heat sources.
- Do not store the device in any location that is dusty, damp, or wet.
- Use a soft lens cloth to clean the device. If the surface of the device screen becomes soiled, clean it with a soft cloth moistened with an approved cleanser. For a list of approved cleansers, see Approved Cleanser Active Ingredients.
- Periodically replace the rechargeable battery to ensure maximum battery life and product performance. Battery life depends on individual usage patterns.

## Battery Safety Guidelines

- The area in which the units are charged should be clear of debris and combustible materials or chemicals. Particular care should be taken where the device is charged in a non commercial environment.
- Follow battery usage, storage, and charging guidelines found in this guide.
- Improper battery use may result in a fire, explosion, or other hazard.
- To charge the mobile device battery, the battery and charger temperatures must be between +32°F and +104°F (0°C and +40°C)
- Do not use incompatible batteries and chargers, including non-Zebra batteries and chargers. Use of an incompatible battery or charger may present a risk of fire, explosion, leakage, or other hazard. If you have any questions about the compatibility of a battery or a charger, contact the Global Customer Support Center.
- For devices that utilize a USB port as a charging source, the device shall only be connected to products that bear the USB-IF logo or have completed the USB-IF compliance program.
- Do not disassemble or open, crush, bend or deform, puncture, or shred battery.



- Severe impact from dropping any battery-operated device on a hard surface could cause the battery to overheat.
- Do not short circuit a battery or allow metallic or conductive objects to contact the battery terminals.
- Do not modify or remanufacture, attempt to insert foreign objects into the battery, immerse or expose to water or other liquids, or expose to fire, explosion, or other hazard.
- Do not leave or store the equipment in or near areas that might get very hot, such as in a parked vehicle or near a radiator or other heat source. Do not place battery into a microwave oven or dryer.
- Battery usage by children should be supervised.
- Please follow local regulations to properly dispose of used re-chargeable batteries.
- Do not dispose of batteries in fire.
- In the event of a battery leak, do not allow the liquid to come in contact with the skin or eyes. If contact has been made, wash the affected area with water for 15 minutes and seek medical advice.
- If you suspect damage to your equipment or battery, contact Customer Support to arrange for inspection.

## Cleaning Instructions



**CAUTION:** Always wear eye protection.

Read warning label on alcohol product before using.

If you have to use any other solution for medical reasons please contact the Global Customer Support Center for more information.



**WARNING:** Avoid exposing this product to contact with hot oil or other flammable liquids. If such exposure occurs, unplug the device and clean the product immediately in accordance with these guidelines.

## Approved Cleanser Active Ingredients

100% of the active ingredients in any cleaner must consist of one or some combination of the following: isopropyl alcohol, bleach/sodium hypochlorite<sup>1</sup> (see important note below), hydrogen peroxide, ammonium chloride or mild dish soap.



**IMPORTANT:** Use pre-moistened wipes and do not allow liquid cleaner to pool.

<sup>1</sup>When using sodium hypochlorite (bleach) based products always follow the manufacturer's recommended instructions: use gloves during application and remove the residue afterwards with a damp alcohol cloth or a cotton swab to avoid prolonged skin contact while handling the device.

Due to the powerful oxidizing nature of sodium hypochlorite the metal surfaces on the device are prone to oxidation (corrosion) when exposed to this chemical in the liquid form (including wipes). In the event that these type of disinfectants come in contact with metal on the device, prompt removal with an alcohol-dampened cloth or cotton swab after the cleaning step is critical.

## Harmful Ingredients

The following chemicals are known to damage the plastics on the device and should not come in contact with the device: acetone; ketones; ethers; aromatic and chlorinated hydrocarbons; aqueous or alcoholic alkaline solutions; ethanolamine; toluene; trichloroethylene; benzene; carbolic acid and TB-lysoform.

Many vinyl gloves contain phthalate additives, which are often not recommended for medical use and are known to be harmful to the housing of the device.

### Device Cleaning Instructions

Do not apply liquid directly to the device. Dampen a soft cloth or use pre-moistened wipes. Do not wrap the device in the cloth or wipe, but gently wipe the unit. Be careful not to let liquid pool around the display window or other places. Allow the unit to air dry before use.



**NOTE:** For thorough cleaning, it is recommended to first remove all accessory attachments, such as hand straps or cradle cups, from the mobile device and to clean them separately.

### Special Cleaning Notes

The device should not be handled while wearing vinyl gloves containing phthalates, or before hands are washed to remove contaminant residue after gloves are removed.

If products containing any of the harmful ingredients listed above are used prior to handling the device, such as hand sanitizer that contain ethanolamine, hands must be completely dry before handling the device to prevent damage to the device.



**IMPORTANT:** If the battery connectors are exposed to cleaning agents, thoroughly wipe off as much of the chemical as possible and clean with an alcohol wipe. It is also recommended to install the battery in the terminal prior to cleaning and disinfecting the device to help minimize buildup on the connectors.

When using cleaning/disinfectant agents on the device, it is important to follow the directions prescribed by the cleaning/disinfectant agent manufacturer.

### Cleaning Materials Required

- Alcohol wipes
- Lens tissue
- Cotton-tipped applicators
- Isopropyl alcohol
- Can of compressed air with a tube.

### Cleaning Frequency

The cleaning frequency is at the customer's discretion due to the varied environments in which the mobile devices are used and may be cleaned as frequently as required. When dirt is visible, it is recommended to clean the mobile device to avoid build up of particles which make the device more difficult to clean later on.

For consistency and optimum image capture, it is recommended to clean the camera window periodically especially when used in environments prone to dirt or dust.

### Cleaning Battery Connectors

To clean the battery connectors:

1. Remove the main battery from the mobile computer.
2. Dip the cotton portion of the cotton-tipped applicator in isopropyl alcohol.

3. To remove any grease or dirt, rub the cotton portion of the cotton-tipped applicator back-and-forth across the connectors on the battery and terminal sides. Do not leave any cotton residue on the connectors.
4. Repeat at least three times.
5. Use a dry cotton-tipped applicator and repeat steps 3 and 4. Do not leave any cotton residue on the connectors.
6. Inspect the area for any grease or dirt and repeat the cleaning process if necessary.



**CAUTION:** After cleaning the battery connectors with bleach-based chemicals, follow the Battery Connector Cleaning instructions to remove bleach from the connectors.

### Cleaning Cradle Connectors

To clean the connectors on a cradle:

1. Remove the DC power cable from the cradle.
2. Dip the cotton portion of the cotton-tipped applicator in isopropyl alcohol.
3. Rub the cotton portion of the cotton-tipped applicator along the pins of the connector. Slowly move the applicator back-and-forth from one side of the connector to the other. Do not leave any cotton residue on the connector.
4. All sides of the connector should also be rubbed with the cotton-tipped applicator.
5. Remove any lint left by the cotton-tipped applicator.
6. If grease and other dirt can be found on other areas of the cradle, use a lint-free cloth and alcohol to remove.
7. Allow at least 10 to 30 minutes (depending on ambient temperature and humidity) for the alcohol to air dry before applying power to cradle.

If the temperature is low and humidity is high, longer drying time is required. Warm temperature and low humidity requires less drying time.



**CAUTION:** After cleaning the cradle connectors with bleach-based chemicals, follow the Cleaning Cradle Connectors instructions to remove bleach from the connectors.

## Troubleshooting

**Table 17** *Troubleshooting the tablet*

Problem	Cause	Solution
Tablet does not turn on.	Battery not charged.	Charge the battery in the tablet.
	Battery not installed properly.	Ensure battery is installed properly.
	System crash.	Perform a soft reset. If the tablet still does not turn on, perform a hard reset. See <a href="#">Resetting the Device on page 53</a> .
Battery did not charge.	Battery failed.	Replace battery. If the tablet still does not operate, try a soft reset, then a hard reset. See <a href="#">Resetting the Device on page 53</a> .
	Tablet removed from cradle before charging completed.	Insert the tablet into the cradle and begin charging. The battery fully charges in approximately four hours.
	Ambient temperature of the cradle is too warm or too cold.	The ambient temperature must be between 0°C and 40°C (32°F and 104°F).
Unable to connect to the wireless network.	SIM card is valid.	Ensure that the micro SIM card is valid and workable if using a mobile network.
	Not within range of network.	Move within the network's service range and the signal strength is good.
	Tablet is in airplane mode.	Ensure that tablet is not in Airplane mode.
The multi-touch screen responds slowly or improperly.	Finger or screen is wet.	Ensure that your hands are clean and dry when touching the screen. Restart the tablet to try again.
Tablet turns itself off.	Tablet is inactive.	The tablet turns off after a period of inactivity. If the tablet is running on battery power.
	Battery is depleted.	Place the tablet in the cradle to re-charge the battery.
	The tablet's battery is low and it powers down to protect memory content.	Place the tablet in a cradle to re-charge the battery.
Screen is not rotating.	Screen rotation is disabled.	Enable screen rotation. See <a href="#">Display Settings on page 29</a> .
	Sensors are disabled.	Sensors are disabled by default. See <a href="#">Interactive Sensor Technology on page 26</a> to enable sensors.

# Specifications

## Technical Specifications

The following tables summarize the tablet's intended operating environment and general technical hardware specifications.

Table 18 Technical Specifications

Item	Description
<b>Physical and Environmental Characteristics</b>	
Dimensions	<p><b>8.4" Configuration:</b> 228 mm W x 150 mm H x 12.7 mm D (9.0 in. L x 5.9 in. W x 0.5 in. H)</p> <p><b>10.1" Configuration:</b> (269 mm W x 181 mm H x 12.7 mm D) 10.6 in. L x 7.1 in. W x 0.5 in. H</p> <p><b>ET51 Enterprise Tablet with Integrated Scanner</b> 246 mm W x 164 mm H x 27 mm D (9.7 in. L x 6.5 in. W x 1.1 in. H)</p>
Weight	<p><b>ET51 8.4" Configuration:</b> 509 g (1.12 lbs)</p> <p><b>ET56 8.4" Configuration:</b> 523 g (1.15 lbs)</p> <p><b>ET56 10.1" Configuration:</b> 725 g (1.60 lbs)</p> <p><b>ET51 Enterprise Tablet with Integrated Scanner</b> 740 g (1.6 lbs)</p>
Display	<p><b>8.4" Configuration:</b> 8.4 in (diagonal) 1600 x 2560 WQXGA with backlight</p> <p><b>10.1" Configuration:</b> 10.1 in (diagonal) 1600 x 2560 WQXGA with backlight</p>
Touch panel	Capacitive 10 point multi-touch
Keypad Options	<p><b>Standard:</b> Virtual, Bluetooth or USB-C</p> <p><b>ET51 with Integrated Scanner:</b> Virtual, Bluetooth. USB (keyboard) with 1-Slot Rugged Communication and Charging Cradle.</p>

Table 18 Technical Specifications (Continued)

Item	Description
Expansion	Integrated connector to easily add accessories
Connectivity	<b>Standard:</b> Docking connector (charge and data); rugged connector for use with rugged dock (charge and data); USB-C side port (charge and data). <b>ET51 with Integrated Scanner:</b> Rugged connector for use with rugged dock (charge and data); USB-C port (charge only).
Notification	LED flash; bar code decode; system and OS notification LED indicator; charge LED indicator
Audio	Stereo speakers and dual front-facing microphones
Battery	<b>8.4" Configuration:</b> 6,440 mAh @ 3.8 VDC (24.4 Wh) rechargeable Lithium Polymer; user replaceable. <b>10.1" Configuration:</b> 9,660 mAh @ 3.85 VDC (37.1 Wh) rechargeable Lithium Polymer; user replaceable.  Optional hot swappable 3,400 mAh, 7.2 VDC (24.4 Wh) secondary battery (equivalent to 3.6 VDC @ 6,800mAh).
<b>Performance Characteristics</b>	
CPU	Qualcomm Snapdragon 660 octa-core processors @ 2.2 GHz.
Operating System	Google Mobile Services (GMS) 8.1.0 Oreo. Upgradeable through Android R.
Memory	4 GB LPDDR4 SDRAM Discrete/ 32 GB MLC eMMC Flash.
<b>Data Capture</b>	
Front Camera	5 MP 1080p full HD optimized for video collaboration and low lighting conditions.
Rear Camera	Image capture: 13 MP auto-focus camera with user controllable LED flash, illumination and aiming; photographs, video, signatures and documents.
Video	1080p (Full HD, 1920 x 1080), Frame rate = 30fps
Scanning	Optional SE4750 8.4" and 10" Expansion Back Optional RS507 and RS507X Hands-free Imager Integrated scanner (ET51 with Integrated Scanner only) Optional RS6000 Scanner DS3608SR/ER USB scanners DS3678 SR/ER Bluetooth scanners
Enterprise Tablet with Integrated Scanner	SE4710 scan engine.
<b>User Environment</b>	
Operating Temperature	-20°C to 50°C (-4°F to 122°F)
Storage Temperature	-20°C to 60°C (-4°F to 140°F)
Battery Charging Temperature	0°C to +40°C (32°F to 104°F)

Table 18 Technical Specifications (Continued)

Item	Description
Humidity	5% to 95% RH (non condensing)
Drop Specification	<b>Standard:</b> 1 m (3.28 ft.) drop to concrete per MIL-STD-810G With optional rugged frame: 1.8 m (5.9 ft.) to concrete per MIL STD 810G. <b>ET51 with Integrated Scanner:</b> 1.2 m (4 ft.) drop to concrete or 1,5 m (5 ft.) to plywood per MIL-STD-810G.
Vibration	Random: 0.02 <sup>2</sup> /Hz, 20Hz to 2kHz 4g RMS 1 hour per axis
Environmental Sealing	IP65
ESD	+/-15kVdc air discharge +/-8kVdc direct discharge +/-8kVdc indirect discharge
<b>WWAN Wireless Data Communications</b>	
	Global LTE (data only) North America LTE (data only): AT&T and Verizon
<b>WLAN Wireless Data Communications</b>	
WLAN radio	802.11 a/b/g/n/d/h/i/k/r/ac; IPv4; IPv6; dual band 2x2 MIMO for transmit and receive
Data Rate	2.4 GHz: 802.11b/g/n - up to 144 Mb per second 5 GHz: 802.11a/n/ac - up to 866.7 Mb per second
Operating Channels	Chan 1 - 13 (2412 - 2472 MHz), Chan 36 - 165 (5180 - 5825 MHz) Channel Bandwidth: 20, 40, 80 MHz Actual operating channels/frequencies depend on regulatory rules and certification agency.
Antenna	Dual band antennas for 2x2 MIMO
WLAN Security	WEP (40 or 104 bit); WPA/WPA2 Personal (TKIP and AES); EAP-TTLS (PAP, MSCHAP, MSCHAPv2), EAP-TLS, EAP-FAST (EAP-GTC, MSCHAPv2), PEAPv0-MSCHAPv2, PEAPv1-EAP-GTC, EAP LEAP.
<b>WPAN Wireless Data Communications</b>	
Bluetooth	Bluetooth v5.0 / 2.1+EDR Class 2 (Bluetooth LE)
Near Field Communication	P2P: ISO 18092 Reader/Writer: ISO 14443 – A-B, MIFARE, FeliCa®, ISO 15693, NFC Forum Tag Types 1 to 4 Card emulation: ISO 14443 – A-B-B', MIFARE, FeliCa RF
GPS	GNSS supports GPS, Galileo and Glonass with LTO technology for Assisted-GPS without sacrificing autonomous operation (ET56 only).
<b>Sensors</b>	
Gyroscope	Maintains orientation based on principles of conservation of angular momentum
Motion Sensor	3-axis accelerometer that enables motion-sensing applications for dynamic screen orientation and power management.
Ambient Light Sensor	Automatically adjusts display brightness, display backlight.
Digital Compass	Independent — does not depend on GPS.

Table 18 Technical Specifications (Continued)

Item	Description
<b>Peripherals and Accessories</b>	
Cradles	Charge Only Cradle Communication and Charging Cradles Rugged Communication Cradle 4-Slot Charge Only Cradle Charging Adapter 4-Slot Battery Charger
Printers	Supports extensive line of Zebra approved printers
Rugged Frame	Provides additional protection for the tablet.

Table 19 Expansion Back Supported Symbologies

Bar Code Type	Symbologies
1D	Bookland EAN, Chinese 2 of 5, Codabar, Code 11, Code 128, Code 32, Code 39, Code 93, Discrete 2 of 5, EAN-8, EAN-13, GS1-128, Interleaved 2 of 5, Inverse 1D, ISBN-128, ISSN EAN, Korean 2 of 5, MSI, Matrix 2 of 5, Trioptic Code 39, UCC Coupon Code, UPCA, UPCE, UPCE1.
2D	Aztec, Aztec Inverse, Composite AB, Composite C, Data Matrix, Data Matrix Inverse, Maxicode, Micro PDF417, Micro QR, PDF417, QR Code, QR Code Inverse, Han Xin, Han Xin Inverse
Postal	Australian Postal, Japan Postal, UK Postal, US Planet, US Postnet, Netherlands KIX Code, USPS 4CB/One Code/Intelligent Mail, UPU FICS Postal



# Index

## A

accessories	
charge only cradle	123
communication and charging cradle	127
four slot charge only cradle	138
rugged communication and charging cradle	131
adaptive frequency hopping	99
airplane mode	28
alarms only	33
albums	
deleting	77
sharing	76
working with albums	76
apn	98
approved cleanser	145
approved cleanser active ingredients	145
apps	46
accessing	48
adding shortcuts	43
battery manager	54
camera	57
datawedge demonstration	63
device central	66
diagnostic tool	68
files	73
photos	75
RxLogger	80
RxLogger Utility	82
shortcuts	43
automatically block sounds and vibrations	34

## B

barcode scanning	
DS3678 digital scanner	107
battery	
low battery notification	27
monitor usage	26
battery charging temperature	150
battery management	26
battery level	26

battery present status	26
battery manager	54
battery optimization	27
battery safety guidelines	144
bluetooth	99
change name	102
disabling	102
discovering devices	102
enabling	101
PIN	99
power states	101
profiles	100
security	99

## C

camera	46, 57
front camera photo settings	58
front camera video settings	60
photo settings	58
rear camera photo settings	59
rear camera video settings	61
recording videos	58
taking photos	57
video settings	60
camera settings	58, 60
change bluetooth name	102
charge only cradle	123
cleaning	145, 146
battery connectors	146
cradle connectors	147
frequency	146
instructions	145
materials	146
cleaning instructions	146
communication and charging cradle	127
connect to WLAN	84
contacts	62
adding	62
deleting	62
editing	62
CPU	150

- cradle
  - connector cleaning . . . . . 147
- cradles
  - charge only . . . . . 123
  - communication and charging . . . . . 127
  - four slot charge only . . . . . 138
  - rugged communication and charging . . . . . 131
- D**
  - data capture . . . . . 11, 105
    - DS3678 digital scanner . . . . . 107
  - datawedge . . . . . 119
    - disable . . . . . 119
    - enable . . . . . 119
  - datawedge demonstration . . . . . 63
  - device central . . . . . 66
    - my device tab . . . . . 67
    - paging an RS6000 ring scanner . . . . . 68
    - peripherals tab . . . . . 67
    - scan and pair tab . . . . . 66
    - unpairing a peripheral . . . . . 67
  - diagnostic tool . . . . . 68
    - battery test information . . . . . 71
    - bluetooth test information . . . . . 72
    - settings . . . . . 71
    - system test information . . . . . 72
    - wlan test information . . . . . 72
  - dimensions . . . . . 149
  - disable bluetooth . . . . . 102
  - discover bluetooth devices . . . . . 102
  - display . . . . . 11, 149
  - display settings . . . . . 29
  - drop specification . . . . . 151
  - DS3678
    - pairing . . . . . 116
    - pairing using Bluetooth HID . . . . . 117
    - pairing using simple serial interface . . . . . 116
    - scanning . . . . . 112
  - DS3678 digital scanner
    - barcode scanning . . . . . 107
    - data capture . . . . . 107
- E**
  - EAP . . . . . 83
  - edit apn . . . . . 98
  - enable bluetooth . . . . . 101
- F**
  - files . . . . . 73
  - finger usage . . . . . 31
  - folders . . . . . 44
  - font size . . . . . 29
- four slot charge only cradle . . . . . 138
- G**
  - general sound setting . . . . . 31
  - getting started . . . . . 19
  - google
    - account setup . . . . . 24
    - mobile services . . . . . 37
- H**
  - hard reset . . . . . 53
  - harmful ingredients . . . . . 145
  - home screen . . . . . 37
    - moving items . . . . . 43
  - humidity . . . . . 151
- I**
  - imager scanning . . . . . 105
  - interactive sensor technology . . . . . 26
- K**
  - keyboards
    - configuration . . . . . 45
    - editing text . . . . . 45
    - entering numbers, symbols, and special characters . . . . . 45
- L**
  - lithium-ion battery . . . . . 14
  - low battery notification . . . . . 27
- M**
  - maintenance
    - approved cleanser active ingredients . . . . . 145
    - battery safety guidelines . . . . . 144
    - clean battery connectors . . . . . 146
    - clean cradle connectors . . . . . 147
    - cleaning frequency . . . . . 146
    - cleaning instructions . . . . . 145
    - cleaning materials required . . . . . 146
    - device cleaning instructions . . . . . 146
    - harmful ingredients . . . . . 145
    - maintaining the device . . . . . 144
    - special cleaning notes . . . . . 146
  - managing notifications . . . . . 41
  - memory . . . . . 11, 150
  - monitor battery usage . . . . . 26

- N**
- near field communications . . . . . 103
  - NFC . . . . . 103
    - reading cards . . . . . 104
  - notational conventions . . . . . 12
  - notification icons . . . . . 40
  - notifications
    - managing . . . . . 41
    - priority notifications only . . . . . 34
- O**
- operating system . . . . . 11, 150
  - operating temperature . . . . . 150
- P**
- pairing
    - DS3678 . . . . . 116
    - RS507/RS6000 hands-free imager . . . . . 114
    - using Bluetooth HID (RS507/RS6000) . . . . . 115
    - using Bluetooth HID(DS3678) . . . . . 117
    - using simple serial interface (DS3678) . . . . . 116
    - using simple serial interface(RS507/RS6000) . . 114
  - parts of the tablet
    - front view . . . . . 14
  - photos . . . . . 75
    - camera settings . . . . . 58
    - cropping . . . . . 78
    - deleting . . . . . 79
    - deleting albums . . . . . 77
    - deleting videos . . . . . 79
    - setting as contact icons . . . . . 78
    - sharing . . . . . 79
    - sharing albums . . . . . 76
    - sharing videos . . . . . 79
    - taking . . . . . 57
    - viewing and browsing . . . . . 77
    - watching videos . . . . . 79
    - working with albums . . . . . 76
    - working with photos . . . . . 77
    - working with videos . . . . . 79
- Q**
- quick access panel . . . . . 41
- R**
- radios . . . . . 11
  - reading NFC cards . . . . . 104
  - related documents . . . . . 13
  - related software . . . . . 13
  - reset device . . . . . 53
    - hard reset . . . . . 53
    - soft reset . . . . . 53
  - RS507
    - scanning . . . . . 107, 110
  - RS507 hands-free imager . . . . . 106
  - RS507 scanning . . . . . 110, 112, 113
  - RS507/RS6000
    - pairing . . . . . 114
    - pairing using Bluetooth HID . . . . . 115
    - pairing using simple serial interface . . . . . 114
  - RS6000
    - bluetooth ring scanner . . . . . 106
    - scanning . . . . . 111
  - RS6000 scanning . . . . . 108, 111
  - rugged communication and charging cradle . . . . . 131
  - RxLogger . . . . . 80
    - configuration . . . . . 80
    - configuration file . . . . . 81
    - disable logging . . . . . 81
    - enable logging . . . . . 81
    - extract log files . . . . . 81
  - RxLogger Utility . . . . . 82
- S**
- scanning . . . . . 105
    - considerations . . . . . 105
    - DS3678 . . . . . 112
    - RS507 . . . . . 107, 110
    - RS6000 . . . . . 111
  - screen font size . . . . . 29
  - screen rotation . . . . . 30
  - security . . . . . 83
  - setting
    - camera . . . . . 58, 60
  - settings
    - automatically block sounds and vibrations . . . . . 34
    - camera photos . . . . . 58
    - camera videos . . . . . 60
    - display . . . . . 29
    - general sound . . . . . 31
    - limit sounds and vibrations . . . . . 33
    - override do not disturb for specific apps . . . . . 35
    - priority notifications only . . . . . 34
    - soft reset . . . . . 53
    - software version . . . . . 12
    - software versions . . . . . 12
    - specifications . . . . . 149
    - starting the tablet . . . . . 19
    - status bar . . . . . 38
    - storage temperature . . . . . 150
- T**
- touch mode . . . . . 31

troubleshooting ..... 148

## U

unpacking ..... 14

## V

### videos

    camera settings ..... 60

    deleting ..... 79

    recording ..... 58

    sharing ..... 79

    watching ..... 79

    working with videos ..... 79

## W

weight ..... 149

WEP ..... 83

widgets ..... 43

    adding ..... 43

### wi-fi

    advanced features ..... 92

wi-fi network ..... 84

WLAN 802.11a/b/g/n ..... 11

WPA ..... 83

WPAN Bluetooth ..... 11

